



E-Star Power Development Co., Ltd. (E-STAR)  
 6F., No. 114, Sec. 3, Minquan E. Rd., Songshan Dist., Taipei City 10543,  
 Taiwan (R.O.C.)  
 Phone : 886-2-2957 5580 Fax : 886-2-2957 7473

## 70W Open Frame type Single output power supply > CFM70S

### Features

- Universal Input Range 85~264Vac
- High Efficiency up to 91%
- 2"x 3" Open Frame Compact Size
- Class I and Class II
- No Load Input Power < 0.15W
- Approval IEC/EN/UL 62368-1 Ed 3.0
- Meets IEC/EN 60335-1
- Approval EN 55032 Class B and CISPR/FCC Class B
- Operating Altitude 5000m
- Continuous Short Circuit Protection
- Over Voltage Protection
- Over Voltage Category OVC II & OVC III

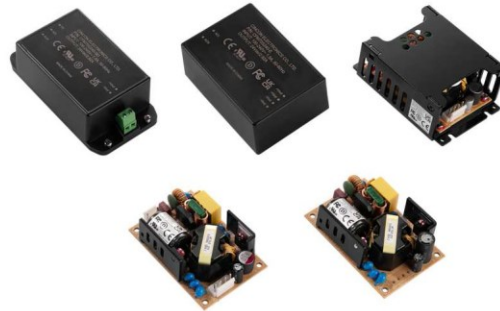

MODEL NUMBER	OUTPUT VOLTAGE	OUTPUT CURRENT	VOLTAGE ACCURACY NOTE1	RIPPLE& NOISE NOTE2	LINE REGULATION NOTE3	LOAD REGULATION NOTE4	%EFF. (Typ.) NOTE5
CFM70S050	5 V	10.0 A	±2%	150 mV	±0.5%	±1%	86%
CFM70S120	12 V	5.80 A	±2%	120 mV	±0.5%	±1%	90%
CFM70S150	15 V	4.65 A	±1%	150 mV	±0.5%	±1%	90%
CFM70S240	24 V	2.92 A	±1%	240 mV	±0.5%	±1%	90%
CFM70S360	36 V	1.94 A	±1%	360 mV	±0.5%	±1%	90%
CFM70S480	48 V	1.46 A	±1%	480 mV	±0.5%	±1%	91%

Note:

1. Voltage accuracy is set at 100% full load.
2. Add a 0.1uF ceramic capacitor and a 10uF E.L. capacitor to output for ripple & noise measurement @20MHz BW.
3. Line regulation is measured from 90V<sub>ac</sub> to 264V<sub>ac</sub> with 100% full load.
4. Load regulation is measured from 10% to full load.
5. Typical efficiency at 230 V<sub>ac</sub>.
6. Standard input and output connectors (CN1 and CN2) wafer with TAIWAN KING PIN TERMINAL PVHI series and mate with JST housing VHR series and JST SVH-41T-P1.1 series crimp terminal and output connectors wire 16AWG.

### PART NUMBER

Series	Number of Outputs	Nominal Output Voltage	Type
CFM70	O	XX	-X (Option)
CFM70	S : Single	050 : 05V	None : Wafer
		120 : 12V	P : PCB Mount
		150 : 15V	CA : Cover
		240 : 24V	E : Encapsulated
		360 : 36V	S : Terminal Block
		480 : 48V	SD : Terminal Block with Din rail

Part Number Example:

**CFM70S120:** Open Frame, 70W, Single 12V<sub>dc</sub> Output



**70W Open Frame type Single output power supply > CFM70S**

**TECHNICAL SPECIFICATIONS**

(All specifications are typical at nominal input, full load at 25°C unless otherwise noted.)

**ABSOLUTE MAXIMUM RATINGS**

PARAMETER	NOTES and CONDITIONS	Device	Min.	Typ.	Max.	Units
Input Voltage	Safety approvals only to the AC input (DC input no safety)	All	85		264	V <sub>ac</sub>
			120		370	V <sub>dc</sub>
Operating Temperature	See Derating Curve	All	-30		80	°C
Storage Temperature		All	-30		85	°C
Operating Altitude	IEC/EN/UL 62368-1 OVC II	All			5000	m
	IEC/EN 62368-1 OVC III				2000	
	Meets IEC/EN 60335-1 OVC II				3000	

**INPUT CHARACTERISTICS**

PARAMETER	NOTES and CONDITIONS	Device	Min.	Typ.	Max.	Units
Operating Voltage Range		All	100		240	V <sub>ac</sub>
Input Frequency Range		All	50		60	Hz
Maximum Input Current	100% Load, V <sub>in</sub> =100V <sub>ac</sub>	All			1.5	A
Leakage Current		All			0.1	mA
Inrush Current	V <sub>in</sub> =240V <sub>ac</sub> , Cold start at 25°C	All		130		A

**OUTPUT CHARACTERISTICS**

PARAMETER	NOTES and CONDITIONS	Device	Min.	Typ.	Max.	Units
Output Voltage Set Point	V <sub>in</sub> =Nominal V <sub>in</sub> , I <sub>o</sub> =I <sub>o</sub> max., T <sub>c</sub> =25°C	CFM70S050	4.90	5	5.10	V <sub>dc</sub>
		CFM70S120	11.76	12	12.24	
		CFM70S150	14.85	15	15.15	
		CFM70S240	23.76	24	24.24	
		CFM70S360	35.64	36	36.36	
		CFM70S480	47.52	48	48.48	
Operating Output Current Range	V <sub>in</sub> =115V <sub>ac</sub> and 230V <sub>ac</sub> , T <sub>c</sub> =25°C	CFM70S050			10.0	A
		CFM70S120			5.80	
		CFM70S150			4.65	
		CFM70S240			2.92	
		CFM70S360			1.94	
		CFM70S480			1.46	
Holdup Time	V <sub>in</sub> =115V <sub>ac</sub>	All		10		ms
Output Voltage Regulation						
Load Regulation	10% Load to full load	All			±1.0	%
Line Regulation	V <sub>in</sub> =High line to low line	All			±0.5	%
Over Voltage Protection	Hiccup mode (Auto recovery)	CFM70S050			6.3	V <sub>dc</sub>
		CFM70S120			15.6	
		CFM70S150			18.0	
		CFM70S240			29.1	
		CFM70S360			43.3	
		CFM70S480			56.8	
Over Current Protection	Hiccup mode (Auto recovery)	All	110		140	%
Short Circuit Protection	Hiccup mode (Auto recovery)	All				



E-Star Power Development Co., Ltd. (E-STAR)

6F., No. 114, Sec. 3, Minquan E. Rd., Songshan Dist., Taipei City 10543, Taiwan (R.O.C.)

Phone : 886-2-2957 5580 Fax : 886-2-2957 7473

## 70W Open Frame type Single output power supply > CFM70S

PARAMETER	NOTES and CONDITIONS	Device	Min.	Typ.	Max.	Units
Output Ripple and Noise	1. Add a 0.1uF ceramic capacitor and a 10uF aluminum electrolytic capacitor to output 2. Oscilloscope is 20MHz band width 3. Ambient Temperature=25°C	CFM70S050			150	mV
		CFM70S120			120	
		CFM70S150			150	
		CFM70S240			240	
		CFM70S360			360	
		CFM70S480			480	
Load Capacitance	1. $V_{in}=115V_{ac}$ and $230V_{ac}$ 2. Output is max. load 3. Ambient temperature=25°C	CFM70S050			10300	uF
		CFM70S120			6000	
		CFM70S150			4700	
		CFM70S240			2920	
		CFM70S360			1980	
		CFM70S480			930	
Efficiency	1. Input voltage is $230V_{ac}$ 2. Output is rated load	CFM70S050		86		%
		CFM70S120		90		
		CFM70S150		90		
		CFM70S240		90		
		CFM70S360		90		
		CFM70S480		91		

### ISOLATION CHARACTERISTICS

PARAMETER	NOTES and CONDITIONS	Device	Min.	Typ.	Max.	Units
Input to Output	1 Minute	All			4250	$V_{ac}$
Isolation Resistance	Input to output	All	100			MΩ

### FEATURE CHARACTERISTICS

PARAMETER	NOTES and CONDITIONS	Device	Min.	Typ.	Max.	Units
Switching Frequency	Pout=max. rated power	All		65		kHz

### GENERAL SPECIFICATIONS

PARAMETER	NOTES and CONDITIONS	Device	Min.	Typ.	Max.	Units
MTBF	$I_o=100%$ ; $T_a=25^\circ C$ per MIL-HDBK-217F	All	500			k hours
Humidity	Non-condensing	All			93	% RH
Shock	Meet MIL-STD-810F Table 516.5, Table 516.5-1 10ms, each axis 3 times( $\pm X$ 、 $\pm Y$ 、 $\pm Z$ axis)	All		75		g
Vibration	Meet MIL-STD-810F Table 514.5C-VIII, 15~2000Hz, X、Y、Z axis, 1 hour (each axis),. Total 3 hrs.	All		4		g
Weight		CFM70S		96.1		grams
		CFM70S-P		94.1		
		CFM70S-CA		183		
		CFM70S-E		223		
		CFM70S-S		236		
		CFM70S-SD		333		
Dimensions	Open Frame (Wafer)	All	3.000x2.000x1.067 Inches (76.20x50.80x27.1 mm)			
	P (PCB Mount)		3.000x2.000x1.142 Inches (76.20x50.80x29mm)			
	CA (Cover)		3.598x2.520x1.358 Inches (91.40x64.00x34.50 mm)			
	E (Encapsulated)		2.170x3.140x1.201 Inches (55.20x79.80x30.50 mm)			
	S (Terminal Block)		2.170x4.200x1.201 Inches (55.20x106.60x30.50 mm)			
	SD (Din rail type)		2.170x4.200x1.783 Inches (55.20x106.60x45.30 mm)			



**70W Open Frame type Single output power supply > CFM70S**

**GENERAL SPECIFICATIONS**

<b>Safety</b>	Class I, Class II, IEC/EN/UL62368-1	Ed 3.0
<b>EMC Emission</b>	EN 55032: 2015+AC: 2016, 47 CFR FCC Part 15 Subpart B, EN 61000-3-2: 2019, EN 61000-3-3: 2013	Class B
Conducted Disturbance	EN 55032, 47 CFR FCC Part 15	Class B
Radiated Disturbance	EN 55032, 47 CFR FCC Part 15	Class B
Harmonic Current Emissions	EN 61000-3-2:2019	
Voltage Fluctuations & Flicker	EN 61000-3-3:2013	
<b>EMC Immunity</b>	EN 55035:2017	
Electrostatic Discharge (ESD)	IEC 61000-4-2:2008, Air Discharge: $\pm 8\text{kV}$ , Contact Discharge: $\pm 4\text{kV}$	Criterion A
Radio-Frequency, Continuous Radiated Disturbance	IEC 61000-4-3:2020	Criterion A
Electrical Fast Transient (EFT)	IEC 61000-4-4:2012, $\pm 0.5\text{kV}$ , $\pm 1\text{kV}$ , $\pm 2\text{kV}$	Criterion A
Surge	IEC61000-4-5:2014, L-N: $\pm 2\text{kV}$ , L-E (Ground): $\pm 4\text{kV}$	Criterion A
Conducted Disturbances, Induced by RF Fields	IEC 61000-4-6:2013	Criterion A
Power Frequency Magnetic Field	IEC 61000-4-8:2009	Criterion A
Voltage Dips	IEC 61000-4-11:2004, Dip: 30% Reduction, Dip >95% Reduction	Criterion A
Voltage Interruptions	IEC 61000-4-11:2004, >95% Reduction	Criterion B

**CHARACTERISTIC CURVE**

**Power Derating Curve**

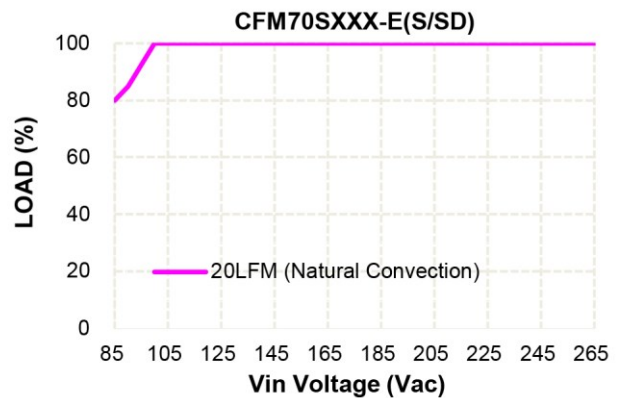
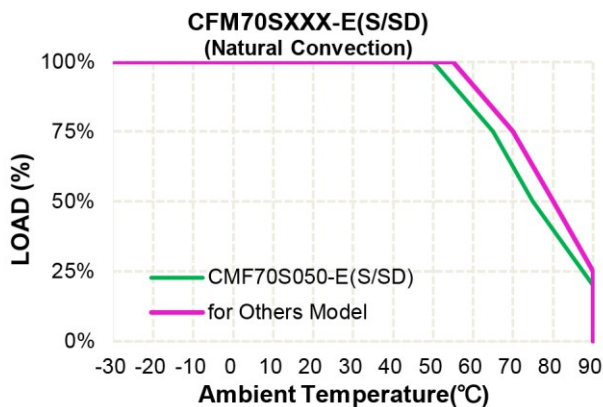
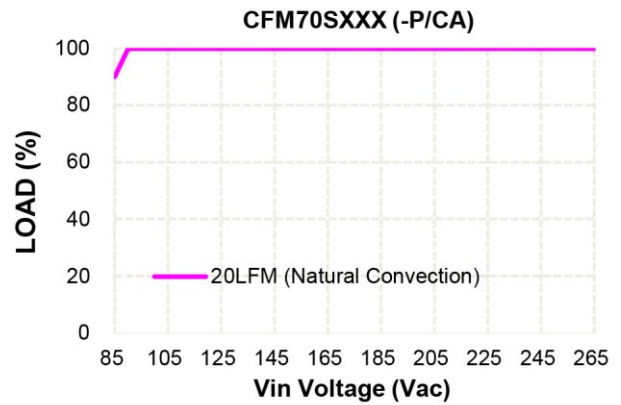
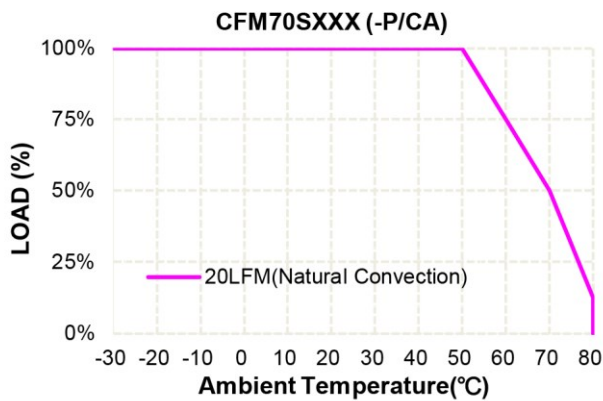



E-Star Power Development Co., Ltd. (E-STAR)

6F., No. 114, Sec. 3, Minquan E. Rd., Songshan Dist., Taipei City 10543, Taiwan (R.O.C.)

Phone : 886-2-2957 5580 Fax : 886-2-2957 7473

## 70W Open Frame type Single output power supply > CFM70S

### Performance Data

CFM70S050 (Eff Vs Io)

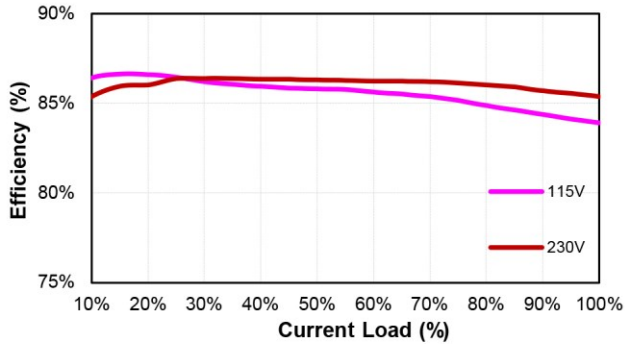

CFM70S120 (Eff Vs Io)

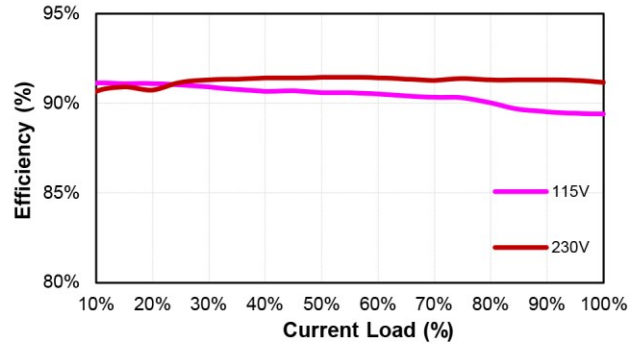

CFM70S150 (Eff Vs Io)

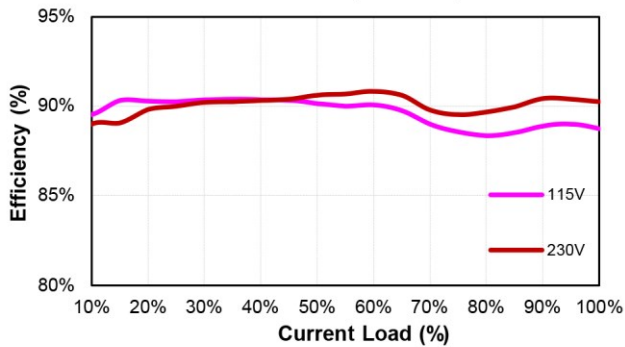

CFM70S240 (Eff Vs Io)

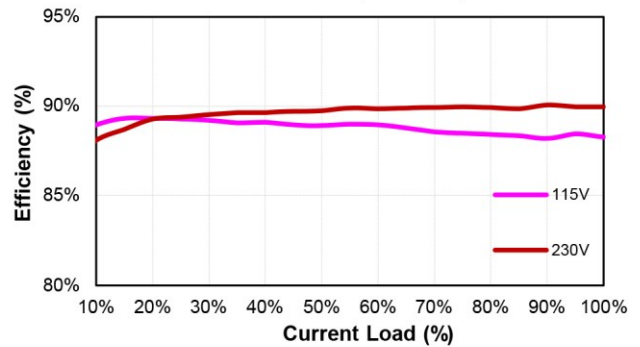

CFM70S360 (Eff Vs Io)

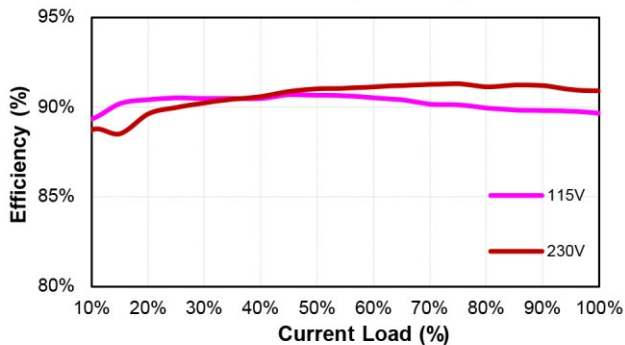

CFM70S480 (Eff Vs Io)

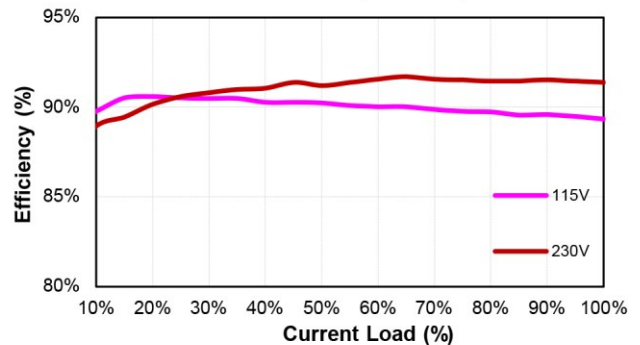



**70W Open Frame type Single output power supply > CFM70S**

**MECHANICAL SPECIFICATION**

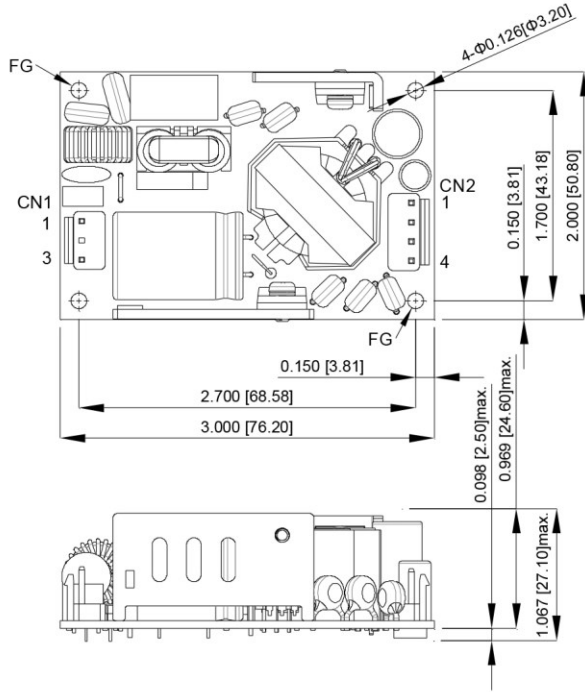

**CFM70SXXX**

AC Input Connector(CN1):TKP PVHI-03N2 or equivalent

Pin	Function	Mating Housing	Terminal
1	ACL	JST VHR-3N or equivalent	JST SVH-21T-P1.1 or equivalent
2	-		
3	ACN		

DC Output Connector(CN2):TKP PVHI-04 or equivalent

Pin	Function	Mating Housing	Terminal
1	+Vout	JST VHR-4N or equivalent	JST SVH-21T-P1.1 or equivalent
2	+Vout		
3	-Vout		
4	-Vout		

All Dimensions in Inches[mm]  
 Tolerance Inches : X.XXX=±0.02  
 Millimeters : X.XX=±0.5

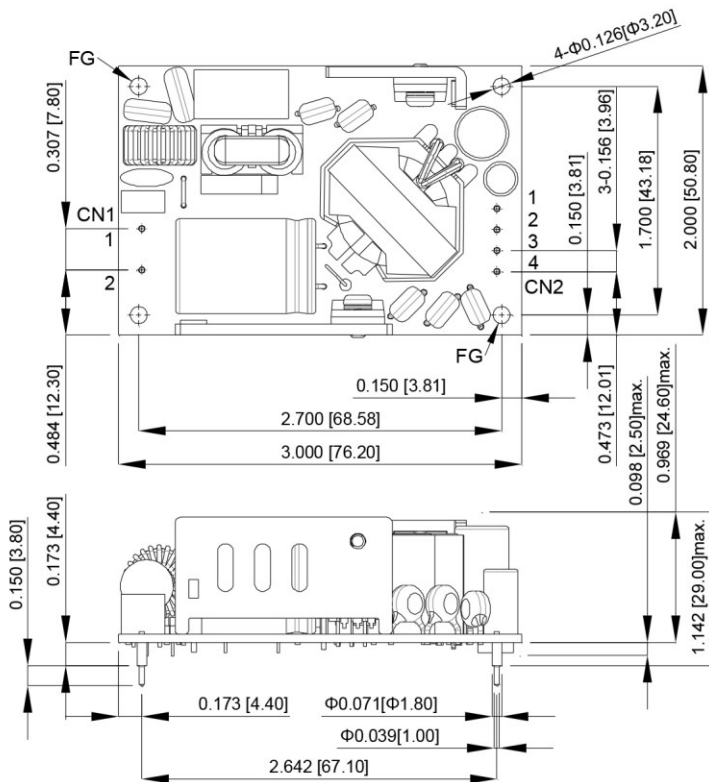

**CFM70SXXX-P**

CN1

PIN CONNECTION	
Pin	Function
1	ACL
2	ACN

CN2

PIN CONNECTION	
Pin	Function
1	+Vout
2	+Vout
3	-Vout
4	-Vout

All Dimensions in Inches[mm]  
 Tolerance Inches : X.XXX=±0.02  
 Millimeters : X.XX=±0.5



**70W Open Frame type Single output power supply > CFM70S**

**MECHANICAL SPECIFICATION**

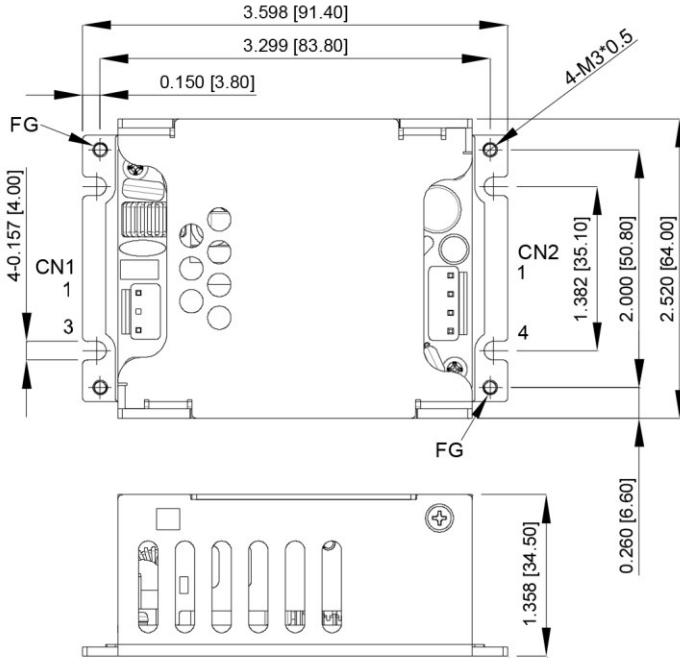

**CFM70SXXX-CA**

AC Input Connector(CN1):TKP PVHI-03N2 or equivalent

Pin	Function	Mating Housing	Terminal
1	ACL	JST VHR-3N or equivalent	JST SVH-21T-P1.1 or equivalent
2	-		
3	ACN		

DC Output Connector(CN2):TKP PVHI-04 or equivalent

Pin	Function	Mating Housing	Terminal
1	+Vout	JST VHR-4N or equivalent	JST SVH-21T-P1.1 or equivalent
2	+Vout		
3	-Vout		
4	-Vout		

All Dimensions in Inches[mm]  
 Tolerance Inches : X.XXX=±0.02  
 Millimeters : X.XX=±0.5

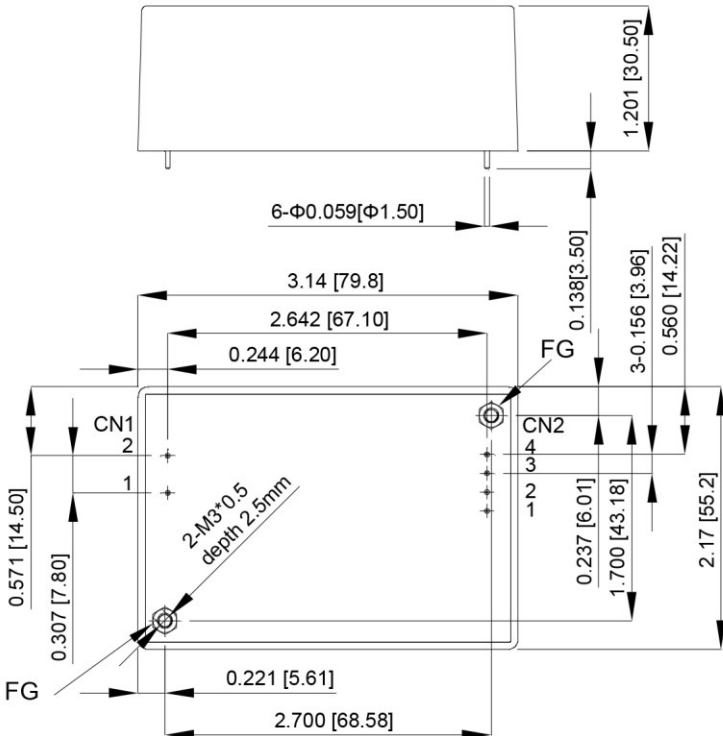

**CFM70SXXX-E**

PIN CONNECTION		
Pin	Function	Wafer
1	ACL	CN1
2	ACN	
1	+Vout	CN2
2	+Vout	
3	-Vout	
4	-Vout	

All Dimensions in Inches[mm]  
 Tolerance Inches : x.xx=±0.03,x.xxx=±0.02  
 Millimeters : x.x=±0.7,x.xx=±0.5



**70W Open Frame type Single output power supply > CFM70S**

**MECHANICAL SPECIFICATION**

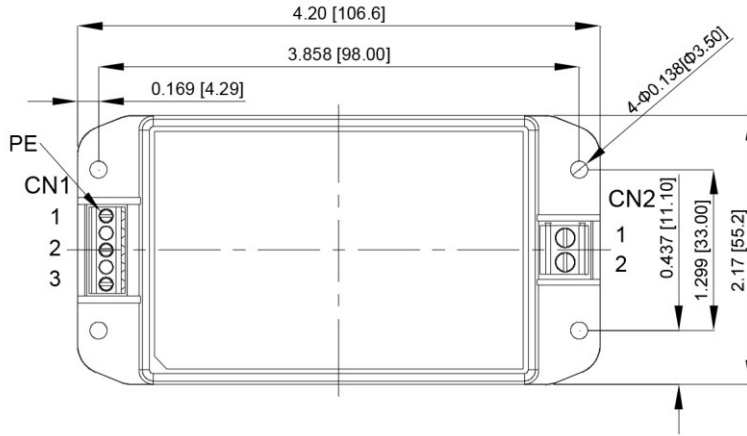

**CFM70SXXX-S**

AC Input Connector(CN1):DINKLE EK350V-03P5 or equivalent

Pin	Function	Mating Wire Range
1	PE	16~30 AWG
2	ACL	
3	ACN	

DC Output Connector(CN2):DINKLE EK500V-02P or equivalent

Pin	Function	Mating Wire Range
1	+Vout	12~16 AWG
2	-Vout	

All Dimensions in Inches[mm]  
 Tolerance Inches: x.xx=±0.03, x .xxx=±0.020  
 Millimeters: x.x=±0.7, x.xx=±0.50

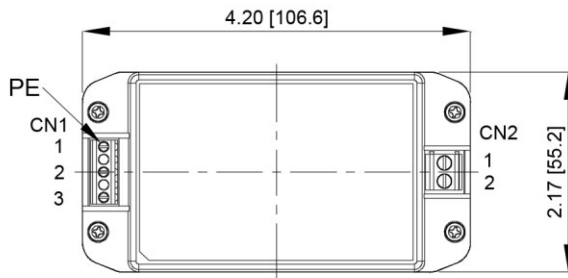

**CFM70SXXX-SD**

AC Input Connector(CN1):DINKLE EK350V-03P5 or equivalent

Pin	Function	Mating Wire Range
1	PE	16~30 AWG
2	ACL	
3	ACN	

DC Output Connector(CN2):DINKLE EK500V-02P or equivalent

Pin	Function	Mating Wire Range
1	+Vout	12~16 AWG
2	-Vout	

All Dimensions in Inches[mm]  
 Tolerance Inches: x.xx=±0.03, x .xxx=±0.020  
 Millimeters: x.x=±0.7, x.xx=±0.50

