



1600W Enclosed type single output power supply > RCP-1600

Dimension			
L	*	W	* H
300	*	85	* 41 (1U) mm
11.8	*	3.35	* 1.61 (1U) inch



Features

- Universal AC input / Full range
(Withstand 300VAC surge input for 5 seconds)
- Built-in active PFC function
- High efficiency up to 93%
- Forced air cooling by built-in DC fan
- Output voltage and constant current level programmable
- Built-in OR-ing FET, support hot swap (hot plug)
- Active current sharing up to 8000W for one 19" rack shelf
- Built-in I²C interface, PMBus protocol
(Optional CANBus protocol)
- Protections: Short circuit / Overload / Over voltage /
Over temperature
- Optional conformal coating
- 5 years warranty

Applications

- Industrial automation
- Distributed power architecture system
- Wireless/telecommunication solution
- Redundant power system
- Electric vehicle charger system
- Constant current source system

Description

RCP-1600 is a 1.6KW single output rack mountable front end AC/DC power supply with a 1U low profile and a high power density up to 25W/inch³. This series operates for 90~264VAC input voltage and offers the models with the DC output mostly demanded from the industry. Each model is cooled by the built-in DC fan with fan speed control, working for the temperature up to 70°C. RCP-1600 provides vast design flexibility by equipping various built-in functions such as the PMBus and CANBus communication protocol, output programming, active current sharing (up to 24000W via three 19" rack shelves, RHP-1U), remote control, auxiliary power, alarm signal, etc. Maximum number that can be monitored by master controller in communication shall be 15 power supplies.

Model Encoding / Order Information

RCP - 1600 - 24

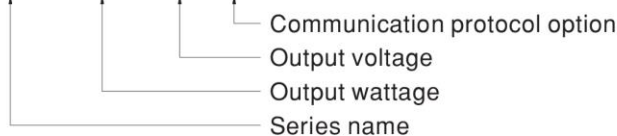

- ※ Note 1: 19" rack shelf, RHP-1U, available.
- ※ Note 2: Control/Monitor unit, RKP-CMU1, available.

Type	Communication Protocol	Note
Blank	PMBus protocol	In Stock
CAN	CANBus protocol	By request



1600W Enclosed type single output power supply > RCP-1600

SPECIFICATION

MODEL		RCP-1600-12	RCP-1600-24	RCP-1600-48	
OUTPUT	DC VOLTAGE	12V	24V	48V	
	RATED CURRENT	125A	67A	33.5A	
	CURRENT RANGE	0 ~ 125A	0 ~ 67A	0 ~ 33.5A	
	RATED POWER	1500W	1608W	1608W	
	RIPPLE & NOISE (max.) Note.2	150mVp-p	200mVp-p	300mVp-p	
	VOLTAGE ADJ. RANGE Note.6	11.5 ~ 15V	23.5 ~ 30V	47.5 ~ 58.8V	
	VOLTAGE TOLERANCE Note.4	±1.0%	±1.0%	±1.0%	
	LINE REGULATION	±0.5%	±0.5%	±0.5%	
	LOAD REGULATION	±0.5%	±0.5%	±0.5%	
	SETUP, RISE TIME	1500ms, 60ms/230VAC at full load			
HOLD UP TIME (Typ.)	16ms / 230VAC at 75% load 10ms / 230VAC at full load				
INPUT	VOLTAGE RANGE Note.5	90 ~ 264VAC 127 ~ 370VDC			
	FREQUENCY RANGE	47 ~ 63Hz			
	POWER FACTOR (Typ.)	0.97/230VAC at full load			
	EFFICIENCY (Typ.)	88.5%	91%	93%	
	AC CURRENT (Typ.) Note.5	14A/115VAC 8A/230VAC	15A/115VAC 8.5A/230VAC		
	INRUSH CURRENT (Typ.)	COLD START 35A/230VAC			
	LEAKAGE CURRENT	<1.5mA / 230VAC			
PROTECTION	OVERLOAD	105 ~ 115% rated output power Protection type : Constant current limiting, unit will shut down o/p voltage after 5 sec. re-power on to recover			
	OVER VOLTAGE	15.75 ~ 18.75V	31.5 ~ 37.5V	63 ~ 75V	
	OVER TEMPERATURE	Shut down o/p voltage, recovers automatically after temperature goes down			
FUNCTION	OUTPUT VOLTAGE PROGRAMMABLE(PV) Note.6	Adjustment of output voltage is allowable to 40 ~ 125% of nominal output voltage(60~125% for 12V). Please refer to the Function Manual in following pages.			
	OUTPUT CURRENT PROGRAMMABLE(PC) Note.6	Adjustment of constant current level is allowable to 20 ~ 100% of rated current. Please refer to the Function Manual in following pages.			
	REMOTE ON-OFF CONTROL	By electrical signal or dry contact Power ON:short Power OFF:open. Please refer to the Function Manual in following pages.			
	REMOTE SENSE	Compensate voltage drop on the load wiring up to 0.5V. Please refer to the Function Manual in following pages.			
	AUXILIARY POWER	5V @ 0.3A, 12V @ 0.8A			
	ALARM SIGNAL	Isolated TTL signal output for T-Alarm, AC-OK and DC-OK			
ENVIRONMENT	WORKING TEMP.	-30 ~ +70°C (Refer to "Derating Curve")			
	WORKING HUMIDITY	20 ~ 90% RH non-condensing			
	STORAGE TEMP., HUMIDITY	-40 ~ +85°C, 10 ~ 95% RH non-condensing			
	TEMP. COEFFICIENT	±0.03%/°C (0 ~ 50°C)			
	VIBRATION	10 ~ 500Hz, 2G 10min./1cycle, 60min. each along X, Y, Z axes			
SAFETY & EMC (Note 7)	SAFETY STANDARDS	UL62368-1, CAN/CSA C22.2 No. 62368-1, TUV EN62368-1, EAC TP TC 004 approved			
	WITHSTAND VOLTAGE	I/P-O/P:3KVAC I/P-FG:2KVAC O/P-FG:1.5KVAC (0.5KVAC for 12V)			
	ISOLATION RESISTANCE	I/P-O/P, I/P-FG, O/P-FG:100M Ohms / 500VDC / 25°C / 70% RH			
	EMC EMISSION	Parameter	Standard	Test Level / Note	
		Conducted	EN55032 (CISPR32)	Class B	
		Radiated	EN55032 (CISPR32)	Class A	
		Harmonic Current	EN61000-3-2	-----	
	EMC IMMUNITY	Voltage Flicker	EN61000-3-3	-----	
		Parameter	Standard	Test Level / Note	
		ESD	EN61000-4-2	Level 3, 8KV air ; Level 2, 4KV contact	
		Radiated	EN61000-4-3	Level 3	
		EFT / Burst	EN61000-4-4	Level 3	
		Surge	EN61000-4-5	Level 4, 2KV/Line-Line 4KV/Line-Earth	
Conducted		EN61000-4-6	Level 3		
Magnetic Field		EN61000-4-8	Level 4		
Voltage Dips and Interruptions	EN61000-4-11	>95% dip 0.5 periods, 30% dip 25 periods, >95% interruptions 250 periods			
OTHERS	MTBF	162.2K hrs min. Telcordia SR-332 (Bellcore) ; 39.3K hrs min. MIL-HDBK-217F (25°C)			
	DIMENSION	300*85*41mm (L*W*H)			
	PACKING	1.87Kg; 6pcs/12.2Kg/1.16CUFT			
NOTE	<ol style="list-style-type: none"> All parameters NOT specially mentioned are measured at 230VAC input, rated load and 25°C of ambient temperature. Ripple & noise are measured at 20MHz of bandwidth by using a 12" twisted pair-wire terminated with a 0.1uf & 47uf parallel capacitor. Under parallel operation ripple of the output voltage may be higher than the SPEC at light load condition. It will go back to normal ripple level once the output load is more than 5%. Tolerance : includes set up tolerance, line regulation and load regulation. Derating may be needed under low input voltages. Please check the derating curve for more details. PV/PC functions when users are not operating on PMBus/CANBus. SVR functions when users are neither operating on PMBus/CANBus nor using PV/PC. The power supply is considered a component which will be installed into a final equipment. All the EMC tests are been executed by mounting the unit on a 720mm*360mm metal plate with 1mm of thickness. The final equipment must be re-confirmed that it still meets EMC directives. For guidance on how to perform these EMC tests, please refer to "EMI testing of component power supplies." The ambient temperature derating of 3.5°C/1000m with fanless models and of 5°C/1000m with fan models for operating altitude higher than 2000m(6500ft). 				



1600W Enclosed type single output power supply > RCP-1600

Block Diagram

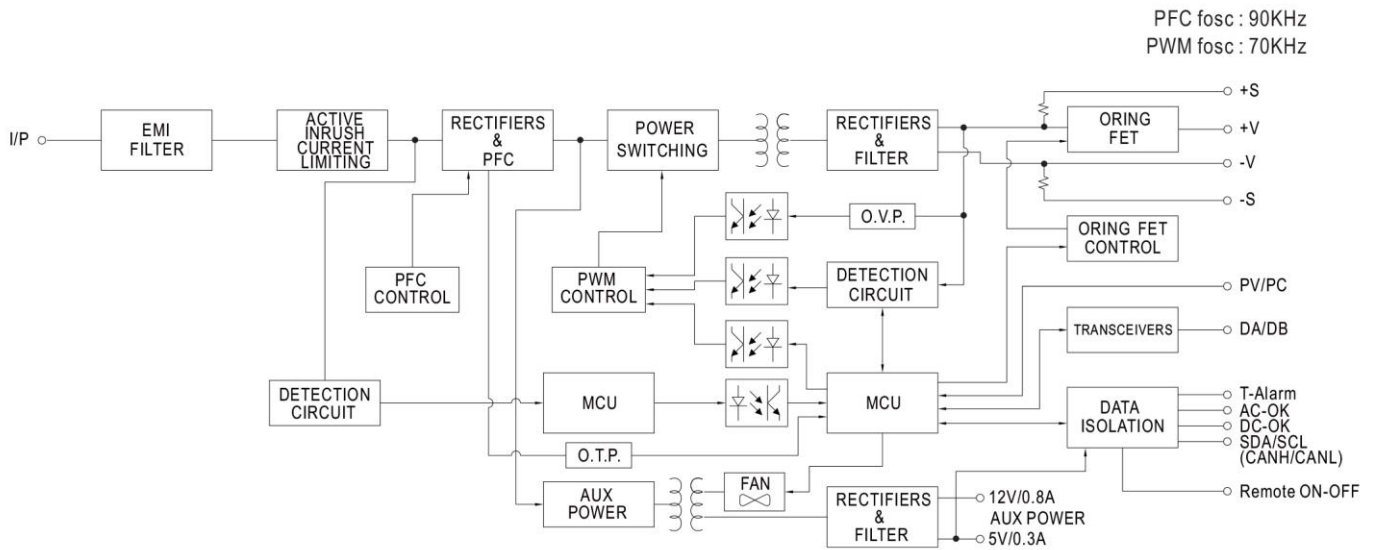

Static Characteristics

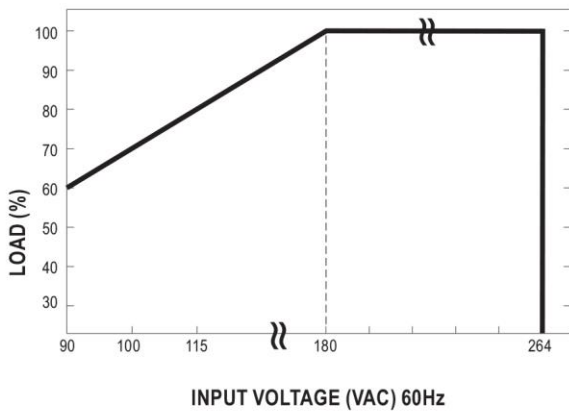

Derating Loads vs Input Voltage

INPUT \ MODEL	12V	24V	48V
180~264VAC	1500W 125A	1608W 67A	1608W 33.5A
115VAC	1200W 100A	1286.4W 53.6A	1286.4W 26.8A
100VAC	1050W 87.5A	1125.6W 46.9A	1125.6W 23.45A
90VAC	900W 75A	964.8W 40.2A	964.8W 20.1A

Derating Curve

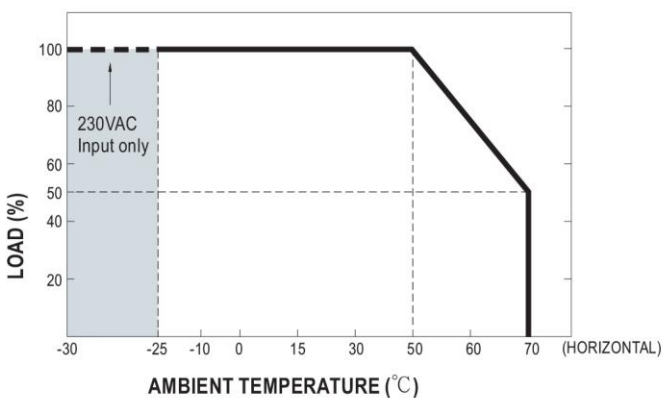

Efficiency vs Load (48V Model)

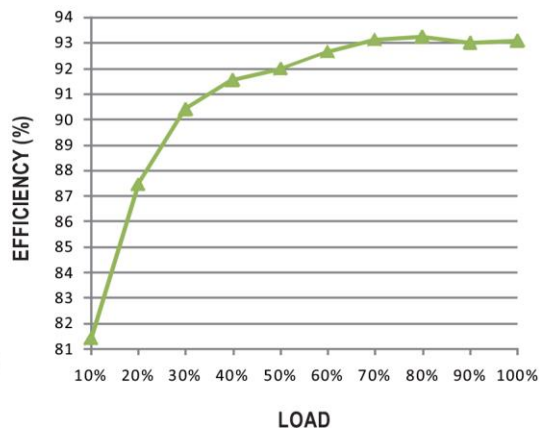

© The curve above is measured at 230VAC.

1600W Enclosed type single output power supply > RCP-1600

Function Manual

1. Voltage Drop Compensation

1.1 Remote Sense

※ The Remote Sense compensates voltage drop on the load wiring up to 0.5V

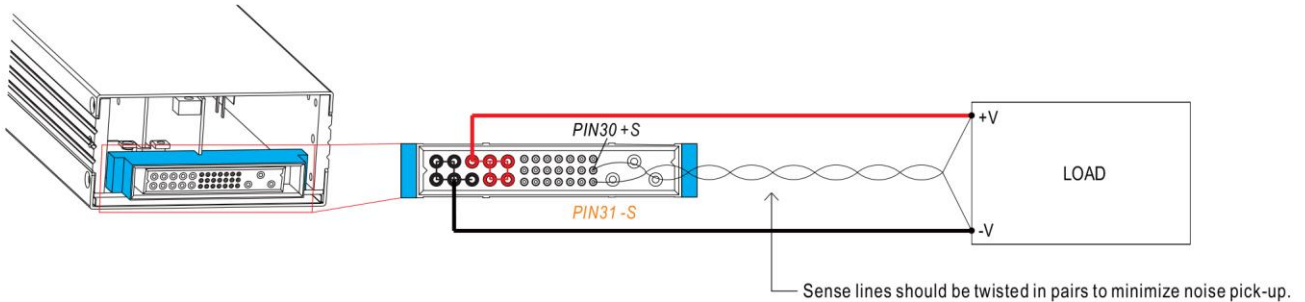

◎ The +S signal should be connected to the positive terminal of the load whereas -S signal to the negative terminal.

1.2 Local Sense

※ The +S,-S have to be connected to the +V(signal),-V(signal), respectively, as the following diagram, in order to get the correct output voltage if Remote Sense is not used.

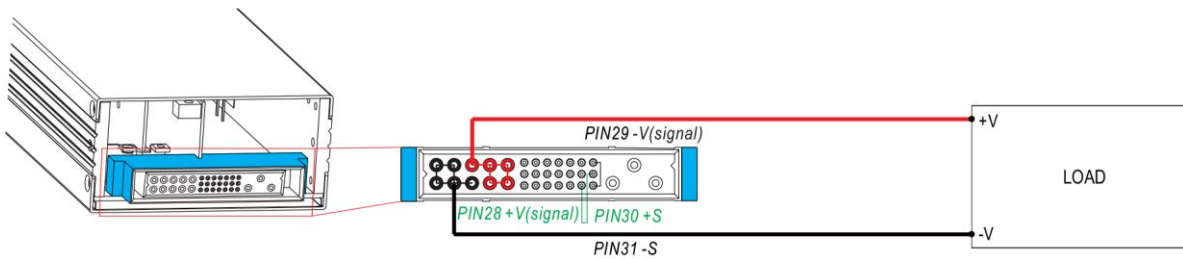

2. Output Voltage Programming (or, PV / remote voltage programming / remote adjust / margin programming / dynamic voltage trim)

※ In addition to the adjustment via the built-in potentiometer, the output voltage can be trimmed to 40~125% of the nominal voltage by applying EXTERNAL VOLTAGE.

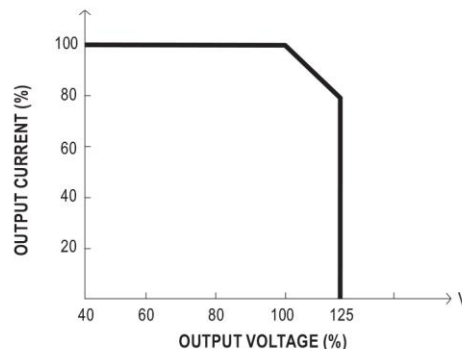
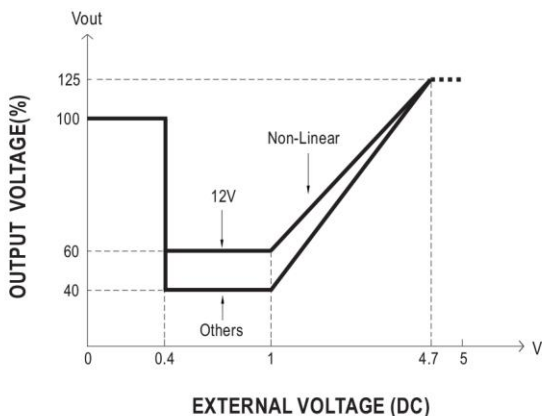
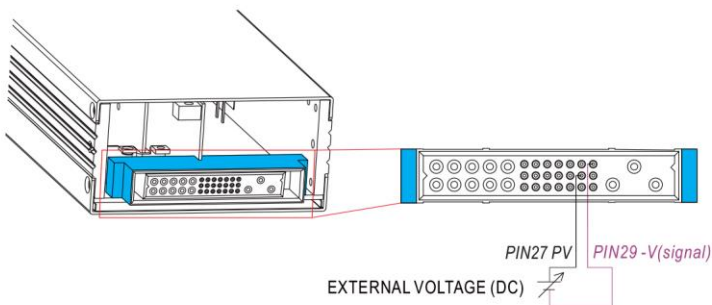

◎ The rated current should change with the Output Voltage Programming accordingly.
 ◎ For Remote Sense / Local Sense, please refer to "Voltage Drop Compensation" section.

1600W Enclosed type single output power supply > RCP-1600

3. Constant Current Level Programming (or, PC / remote current programming / dynamic current trim)

※ The constant current level can be trimmed to 20~100% of the rated current by applying EXTERNAL VOLTAGE.

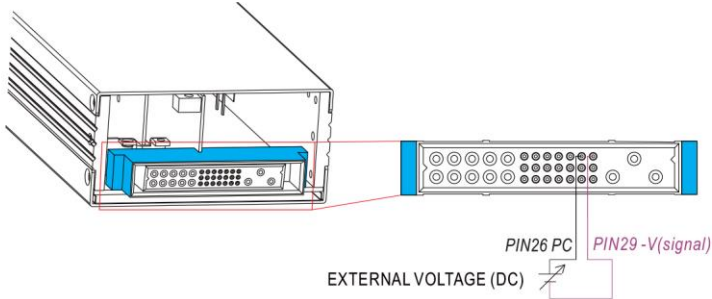

◎ For Remote Sense / Local Sense, please refer to "Voltage Drop Compensation" section.

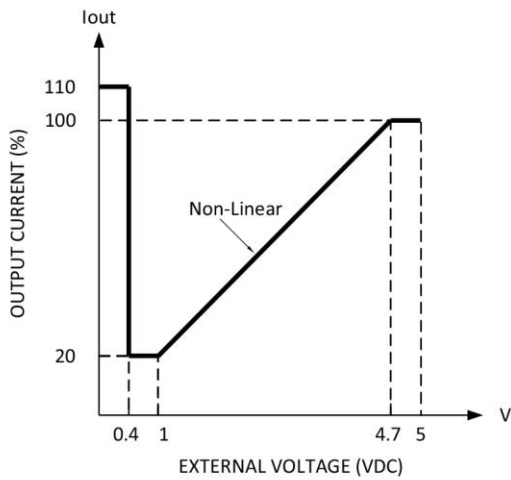

4. Remote ON-OFF Control

The power supply can be turned ON/OFF individually or along with other units by using the "Remote ON-OFF" function.

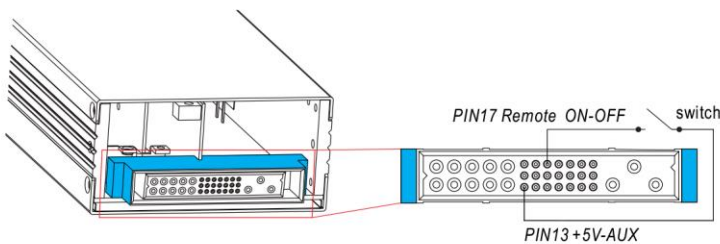

Between Remote ON-OFF and +5V-AUX	Power Supply Status
Switch Short	ON
Switch Open	OFF

5. PMBus Communication Interface

RCP-1600 supports PMBus Rev. 1.1 with maximum 100KHz bus speed, allowing information reading, status monitoring, output trimming, etc. For details, please refer to the Function Manual.



1600W Enclosed type single output power supply > RCP-1600

■ Mechanical Specification

Case No.250 Unit:mm

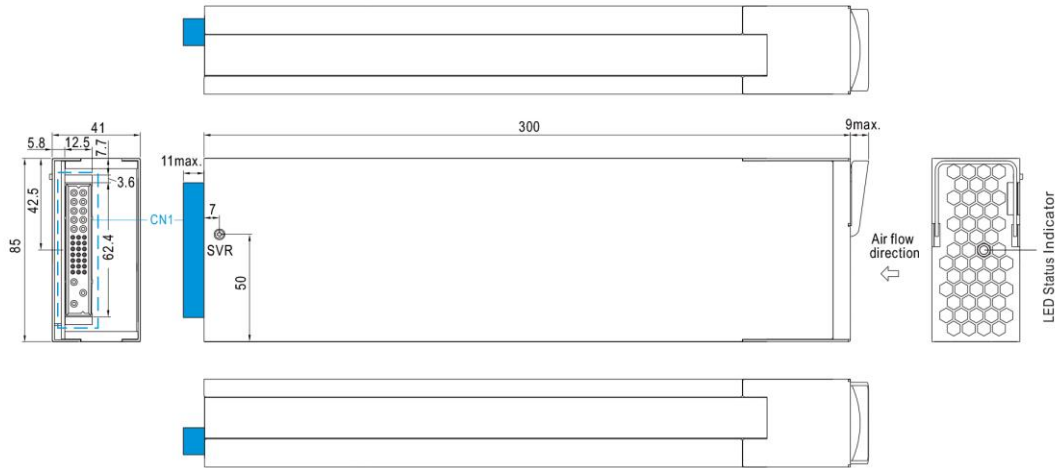

※ LED Status Indicators

LED	Description
● Green	The power supply functions normally.
● Red	The LED will present a constant red light when the abnormal status (OTP, OLP, fan fail and charging timeout) arises.
● Red (Flashing)	The LED will flash with the red light when the internal temperature reaches 60°C; under this condition, the unit still operates normally without entering OTP. (In the meantime, an alarm signal will be sent out through the PMBus interface.)

※ Input / Output Connector Pin No. Assignment(CN1) : Positronic PCIM34W13M400A1

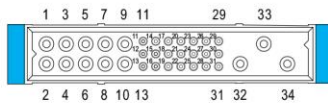

Mating Housing Positronic PCIM34W13F400A1

Pin No.	Function	Description
1,2,3,4,6	-V	Negative output terminal.
5,7,8,9,10	+V	Positive output terminal.
11	+12V-AUX	Auxiliary voltage output, 10.8~13.2V, referenced to GND-AUX (pin 12). The maximum load current is 0.8A. This output has the built-in "Oring diodes" and is not controlled by the Remote ON/OFF control.
12	GND-AUX	Auxiliary voltage output GND. The signal return is isolated from the output terminals (+V & -V).
13	+5V-AUX	Auxiliary voltage output, 4.5~5.5V, referenced to GND-AUX (pin 12). The maximum load current is 0.3A. This output has the built-in "Oring diodes" and is not controlled by the Remote ON/OFF control.
14	SCL	For PMBus model: Serial Clock used in the PMBus interface. (Note.2)
	CANL	For CANBus model: Data line used in CANBus interface. (Note.2)
15	SDA	For PMBus model: Serial Data used in the PMBus interface. (Note.2)
	CANH	For CANBus model: Data line used in CANBus interface. (Note.2)
16	T-ALARM	High (4.5 ~ 5.5V) : When the internal temperature exceeds the limit of temperature alarm, or when fan fails. Low (-0.1 ~ 0.5V) : When the internal temperature is normal, and when fan normally works. The maximum sourcing current is 10mA and only for output.(Note.2)
17	Remote ON-OFF	The unit can turn the output ON/OFF by electrical signal or dry contact between Remote ON/OFF and +5V-AUX. (Note.2) Short (4.5 ~ 5.5V) : Power ON ; Open (0 ~ 0.5V) : Power OFF ; The maximum input voltage is 5.5V.
18	DC-OK	High (4.5 ~ 5.5V) : When the Vout ≤ 80%±5%. Low (-0.1 ~ 0.5V) : When Vout ≥ 80%±5%. The maximum sourcing current is 10mA and only for output. (Note.2)
19	AC-OK	High (4.5 ~ 5.5V) : When the input voltage is ≥ 87Vrms . Low (-0.1 ~ 0.5V) : When the input voltage is ≤ 75Vrms. The maximum sourcing current is 10mA and only for output. (Note.2)
20,21,22,23	A3,A2,A1,A0	PMBus / CANBus interface address lines. (Note.1)
24,25	DB,DA	Differential digital signal for parallel control. (Note.1)
26	PC	Connection for constant current level programming. (Note.1)
27	PV	Connection for output voltage programming. (Note.1)
28	+V (Signal)	Positive output voltage signal. It is for local sense; it cannot be connected directly to the load.
29	-V (Signal)	Negative output voltage signal. It is for local sense; and certain function reference; it cannot be connected directly to the load.
30	+S	Positive sensing for remote sense.
31	-S	Negative sensing for remote sense.
32	FG	AC Ground connection.
33	AC/L	AC Line connection.
34	AC/N	AC Neutral connection.

Note1: Non-isolated signal, referenced to [-V(signal)].
 Note2: Isolated signal, referenced to GND-AUX.