



E-Star Power Development Co., Ltd. (E-STAR)
 1F., No.40, Juren Ln., Sec. 2, Sanmin Rd., Banciao Dist., New Taipei City
 22069, Taiwan (R.O.C.)
 Phone : 886-2-2957 5580 Fax : 886-2-2957 7473

480W Enclosed type single output power supply > HEP-480



IP65 IP68 (optional)

UL62368-1 TPTC004 IEC62368-1



Features

- Universal AC input / Full range(up to 305VAC)
- Built-in active PFC function
- High efficiency up to 95%
- Fanless design, cooling by free air convection
- -55~+65°C wide operating range
- Aluminum case and filling with heat-conducted silicone
- IP65 design, optional IP68 rated model available
- Meet 6KV surge immunity level
- Withstand 10G vibration test
- Operating altitude up to 5000 meters (Note.7)
- Protections: Short circuit / Overload / Over voltage / Over temperature
- 6 years warranty

Applications

- Outdoor telecommunication equipment
- Outdoor electronic signage and billboard
- Petroleum plant or mine shaft facility

Description

HEP-480 is a 480W industrial AC/DC power supply featuring the outstanding capability to operate under highly humid, dusty, oily, and high-vibration harsh environment. The entire series is housed with the aluminum case and fully potted with heat-conducted silicone. Thanks to state-of-the-art design, the working efficiency is up to 95%, enabling HEP-480 perfectly work between -55°C and +65°C under free air convection.

Model Encoding

HEP - 480 - 24 A

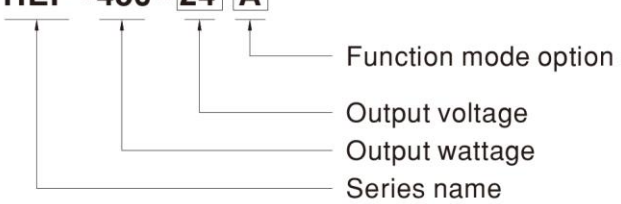

{ A : Standard model, IP65, Vo and Io level can be adjusted through internal potentiometer.
 Blank : Optional model, IP68, with fixed Vo and Io level.



E-Star Power Development Co., Ltd. (E-STAR)
 1F., No.40, Juren Ln., Sec. 2, Sanmin Rd., Banciao Dist., New Taipei City
 22069, Taiwan (R.O.C.)
 Phone : 886-2-2957 5580 Fax : 886-2-2957 7473

480W Enclosed type single output power supply > HEP-480

SPECIFICATION

MODEL		HEP-480-24□	HEP-480-36□	HEP-480-48□	HEP-480-54□
OUTPUT	DC VOLTAGE	24V	36V	48V	54V
	RATED CURRENT	20A	13.3A	10A	8.9A
	RATED POWER	480W	478.8W	480W	480.6W
	RIPPLE & NOISE (max.) Note.2	200mVp-p	250mVp-p	250mVp-p	350mVp-p
	VOLTAGE ADJ. RANGE Note.5	Adjusted for A-type only (via built-in potentiometer)			
		20.4 ~ 25.2V	30.6 ~ 37.8V	40.8 ~ 50.4V	45.9 ~ 56.7V
	CURRENT ADJ. RANGE	Adjusted for A-type only (via built-in potentiometer)			
		10 ~ 20A	6.6 ~ 13.3A	5 ~ 10A	4.4 ~ 8.9A
	VOLTAGE TOLERANCE Note.3	±1.0%	±1.0%	±1.0%	±1.0%
	LINE REGULATION	±0.5%	±0.5%	±0.5%	±0.5%
	LOAD REGULATION	±0.5%	±0.5%	±0.5%	±0.5%
SETUP, RISE TIME Note.4	500ms, 80ms 115VAC/230VAC				
HOLD UP TIME (Typ.)	16ms 115VAC/230VAC				
INPUT	VOLTAGE RANGE Note.5	85~264VAC (277VAC operational)		120~370VDC(390VDC operational)	
	FREQUENCY RANGE	47 ~ 63Hz			
	POWER FACTOR (Typ.)	PF ≥ 0.98/115VAC, PF ≥ 0.97/230VAC, PF ≥ 0.95/277VAC at full load			
	EFFICIENCY (Typ.)	94%	95%	94.5%	95%
	AC CURRENT (Typ.)	5A / 115VAC	2.45A / 230VAC	2A/277VAC	
	INRUSH CURRENT(Typ.)	COLD START 35A at 230VAC			
	LEAKAGE CURRENT	<0.75mA / 277VAC			
PROTECTION	OVER CURRENT	105 ~ 125% Constant current limiting, recovers automatically after fault condition is removed			
	SHORT CIRCUIT	Constant current limiting, recovers automatically after fault condition is removed			
	OVER VOLTAGE	27 ~ 33V	40 ~ 50V	53 ~ 63V	60 ~ 70V
		Shut down output voltage, re-power on to recover			
OVER TEMPERATURE	Shut down output voltage, re-power on to recover				
ENVIRONMENT	WORKING TEMP.	-55 ~ +65°C (Refer to "Derating Curve")			
	WORKING HUMIDITY	20 ~ 95% RH non-condensing			
	STORAGE TEMP., HUMIDITY	-60 ~ +80°C, 10 ~ 95% RH non-condensing			
	TEMP. COEFFICIENT	±0.02%/°C (0 ~ 60°C)			
VIBRATION	20 ~ 500Hz, 10G 12min./1cycle, period for 72min. each along X, Y, Z axes				
SAFETY & EMC	SAFETY STANDARDS Note.7	UL62368-1, IEC/EN62368-1, IP65 (or IP68 for HEP-480 Blank-Type), EAC TP TC 004 approved ;			
	WITHSTAND VOLTAGE	I/P-O/P:3.75KVAC I/P-FG:2KVAC O/P-FG:1.5KVAC			
	ISOLATION RESISTANCE	I/P-O/P, I/P-FG, O/P-FG:100M Ohms / 500VDC / 25°C / 70% RH			
	EMC EMISSION	Compliance to EN55032 (CISPR32) Class B, EN61000-3-2,-3, EAC TP TC 020			
EMC IMMUNITY	Compliance to EN61000-4-2,3,4,5,6,8,11, EN55024, light industry level (surge 6KV), criteria A, EAC TP TC 020				
OTHERS	MTBF	89.8K hrs min. MIL-HDBK-217F (25°C)			
	DIMENSION	262*125*43.8mm (L*W*H)			
	PACKING	2.8Kg;4pcs/11.5Kg/0.55CUFT			
NOTE	<ol style="list-style-type: none"> All parameters NOT specially mentioned are measured at 230VAC input, rated load and 25°C of ambient temperature. Ripple & noise are measured at 20MHz of bandwidth by using a 12" twisted pair-wire terminated with a 0.1uf & 47uf parallel capacitor. Tolerance : includes set up tolerance, line regulation and load regulation. Length of set up time is measured at cold first start. Turning ON/OFF the power supply may lead to increase of the setup time. Derating may be needed under low input voltages. Please refer to the "STATIC CHARACTERISTICS" for more details. The power supply shall be regarded as one component of the final system. The EMC performance will be affected by the complete system installation and/or configuration, the final system manufacturers must re-verify overall EMC directive with the complete installation and/or configuration. The water protection level test for the IP68 rating is performed 1000mm below the surface of the water for 1 month. The ambient temperature derating of 3.5°C/1000m with fanless models and of 5°C/1000m with fan models for operating altitude higher than 2000m(6500ft). 				



480W Enclosed type single output power supply > HEP-480

Block Diagram

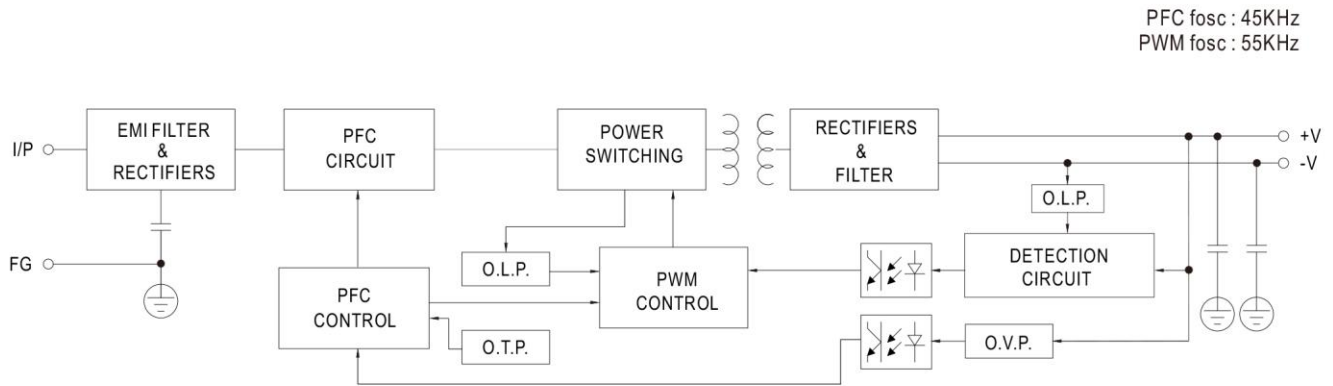

Derating Curve

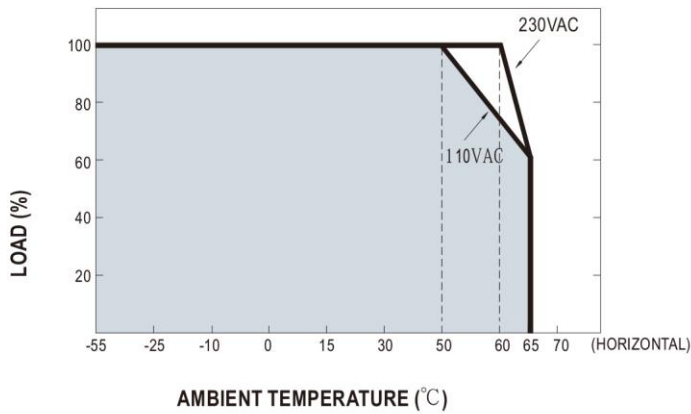

Static Characteristics

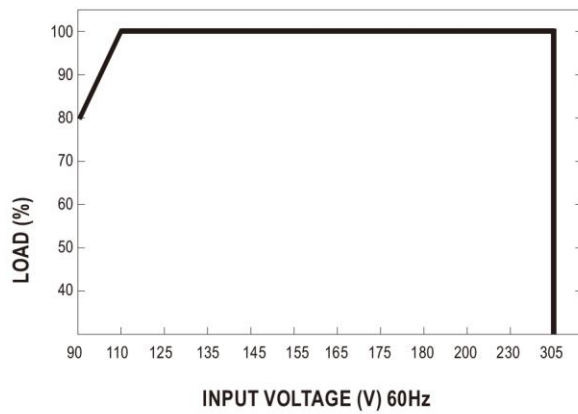



480W Enclosed type single output power supply > HEP-480

Mechanical Specification

Case No. 251 Unit:mm

※ **A-Type (standard model)**

For 24V,36V

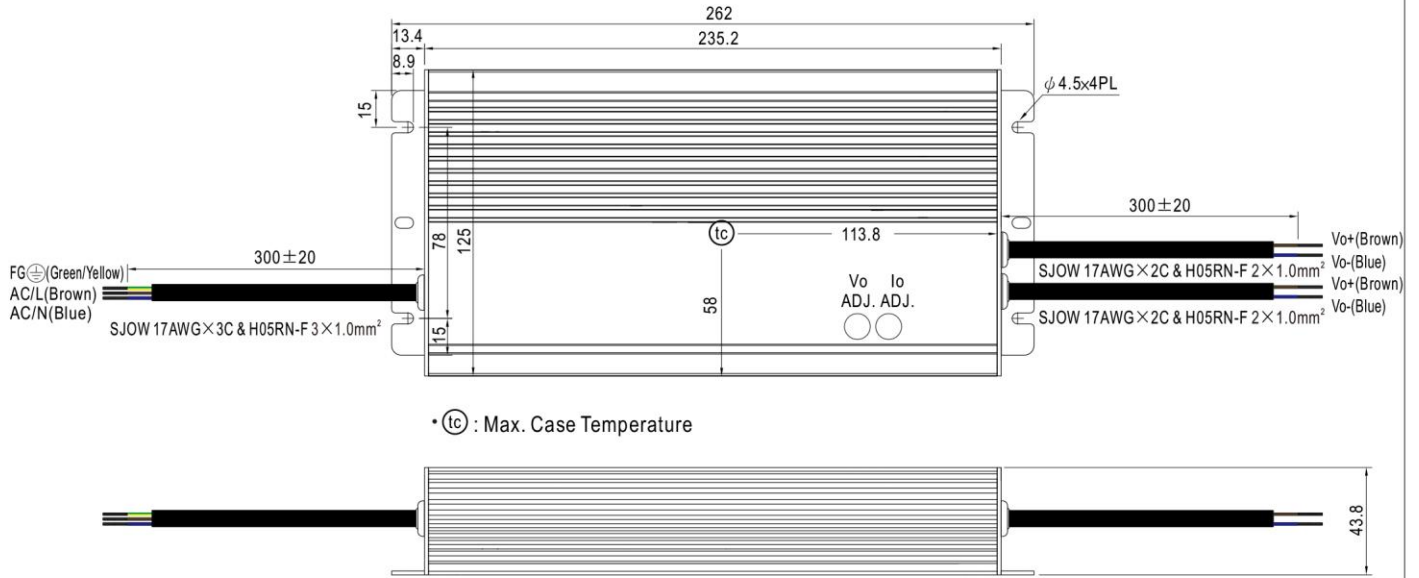

For Others

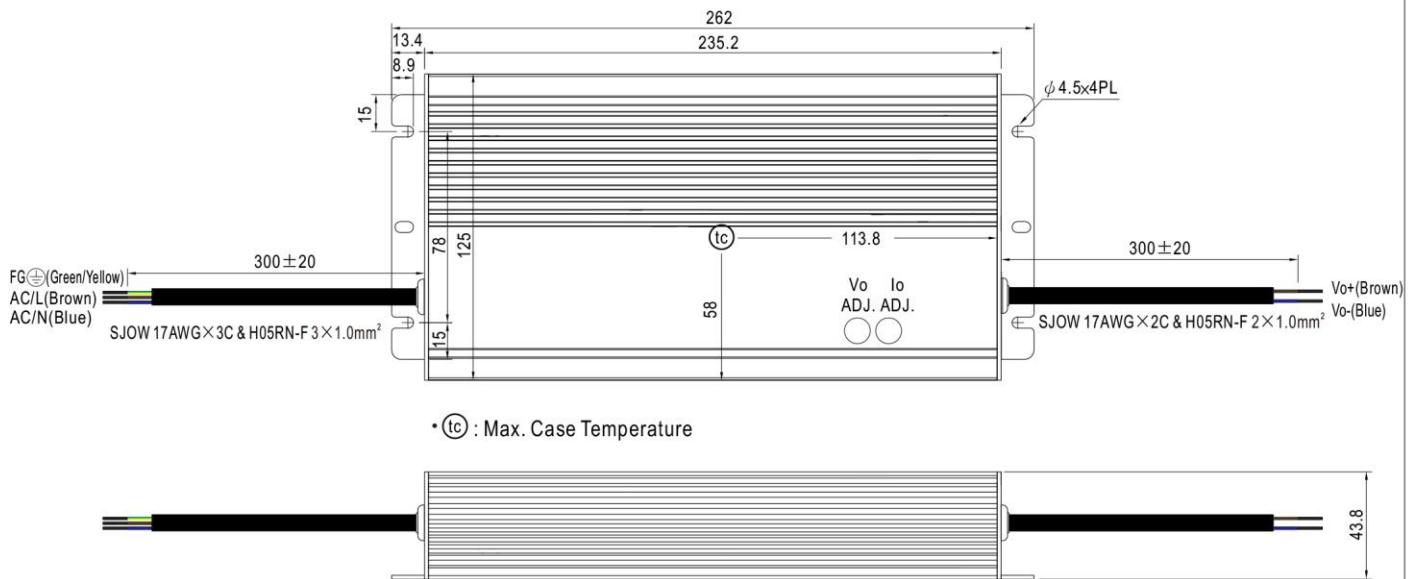



E-Star Power Development Co., Ltd. (E-STAR)

1F., No.40, Juren Ln., Sec. 2, Sanmin Rd., Banciao Dist., New Taipei City
22069, Taiwan (R.O.C.)

Phone : 886-2-2957 5580 Fax : 886-2-2957 7473

480W Enclosed type single output power supply > HEP-480

※ **Blank-Type (optional model)**

For 24V,36V

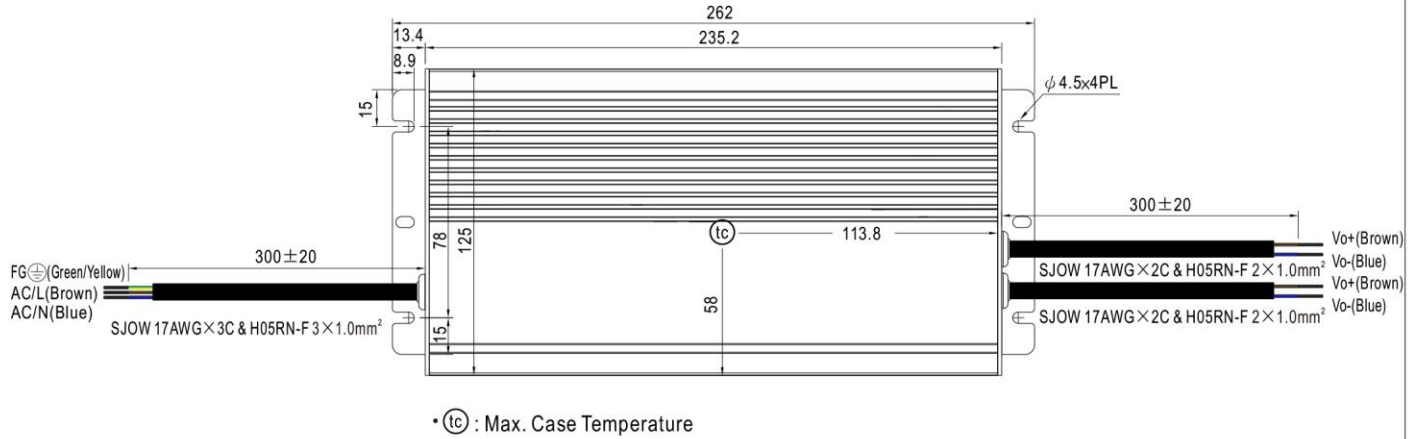

For Others

