



E-Star Power Development Co., Ltd. (E-STAR)
 1F., No.40, Juren Ln., Sec. 2, Sanmin Rd., Banciao Dist., New Taipei City
 22069, Taiwan (R.O.C.)
 Phone : 886-2-2957 5580 Fax : 886-2-2957 7473

100W Enclosed type single output power supply > HEP-100



IP65 IP68 (optional) (FC) c UL us EAC CB CE
 UL62368-1 TPTC004 IEC62368-1



Features

- Universal AC input / Full range (up to 305VAC)
- Built-in active PFC function
- High efficiency up to 93%
- Fanless design, cooling by free air convection
- -55~+70°C wide operating range
- Aluminum case and filling with heat-conducted silicone
- IP65 design, optional IP68 rated model available
- Meet 6KV surge immunity level
- Withstand 10G vibration test
- Protections: Short circuit / Overload / Over voltage / Over temperature
- Operating altitude up to 5000 meters (Note.9)
- 6 years warranty

Applications

- Outdoor telecommunication equipment
- Outdoor electronic signage and billboard
- Petroleum plant or mine shaft facility

Description

HEP-100 is a 100W industrial AC/DC power supply featuring the outstanding capability to operate under highly humid, dusty, oily, and high-vibration harsh environment. The entire series is housed with the aluminum case and fully potted with heat-conducted silicone. Thanks to state-of-the-art design, the working efficiency is up to 93%, enabling HEP-100 perfectly work between -55°C and +70°C under free air convection.

Model Encoding

HEP - 100 - 12 A

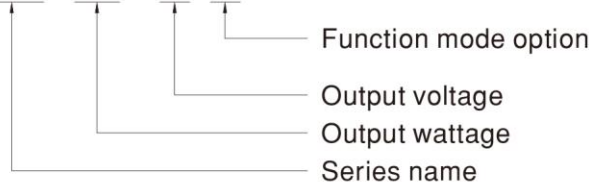

A : Standard model, IP65, Vo and Io level can be adjusted through internal potentiometer.
 Blank : Optional model, IP68, with fixed Vo and Io level.



100W Enclosed type single output power supply > HEP-100

SPECIFICATION

MODEL		HEP-100-12□	HEP-100-15□	HEP-100-24□	HEP-100-36□	HEP-100-48□	HEP-100-54□
OUTPUT	DC VOLTAGE	12V	15V	24V	36V	48V	54V
	RATED CURRENT	8.34A	6.67A	4A	2.65A	2A	1.77A
	RATED POWER	100.08W	100.05W	96W	95.4W	96W	95.58W
	RIPPLE & NOISE (max.) Note.2	120mVp-p	150mVp-p	150mVp-p	200mVp-p	200mVp-p	200mVp-p
	VOLTAGE ADJ. RANGE Note.5	10.8 ~ 13.5V	13.5 ~ 17V	22 ~ 27V	33 ~ 40V	43 ~ 53V	49 ~ 58V
	CURRENT ADJ. RANGE	Can be adjusted by internal potentiometer for A type only					
		5 ~ 8.34A	4 ~ 6.67A	2.5 ~ 4A	1.65 ~ 2.65A	1.25 ~ 2A	1.1 ~ 1.77A
	VOLTAGE TOLERANCE Note.3	±2.0%	±1.5%	±1.0%	±1.0%	±1.0%	±1.0%
	LINE REGULATION	±0.5%	±0.5%	±0.5%	±0.5%	±0.5%	±0.5%
	LOAD REGULATION	±2.0%	±1.5%	±0.5%	±0.5%	±0.5%	±0.5%
SETUP, RISE TIME Note.7	1200ms,50ms/115VAC 500ms,50ms/230VAC at full load						
HOLD UP TIME (Typ.)	16ms at full load 230VAC /115VAC						
INPUT	VOLTAGE RANGE Note.4	85~264VAC (277VAC operational) 120~370VDC(390VDC operational)					
	FREQUENCY RANGE	47 ~ 63Hz					
	POWER FACTOR (Typ.)	PF>0.98/115VAC, PF>0.95/230VAC, PF>0.91/277VAC at full load					
	EFFICIENCY (Typ.)	92%	92%	93%	93%	93%	93%
	AC CURRENT (Typ.)	1.2A / 115VAC	0.55A / 230VAC	0.5A / 277VAC			
	INRUSH CURRENT(Typ.)	COLD START 60A at 230VAC					
	LEAKAGE CURRENT	<0.75mA / 277VAC					
PROTECTION	OVERLOAD	105 ~ 125% Protection type : Constant current limiting, recovers automatically after fault condition is removed					
	SHORT CIRCUIT	Constant current limiting, recovers automatically after fault condition is removed					
	OVER VOLTAGE	14 ~ 17V	18 ~ 21V	28 ~ 34V	41 ~ 46V	54 ~ 63V	59 ~ 65V
	OVER TEMPERATURE	Shut down o/p voltage, recovers automatically after temperature goes down					
ENVIRONMENT	WORKING TEMP.	-55 ~ +70°C (Refer to "Derating Curve")					
	WORKING HUMIDITY	20 ~ 95% RH non-condensing					
	STORAGE TEMP., HUMIDITY	-60 ~ +85°C, 10 ~ 95% RH non-condensing					
	TEMP. COEFFICIENT	±0.03%/°C (0 ~ 60°C)					
	VIBRATION	20 ~ 500Hz, 10G 12min./1cycle, period for 72min. each along X, Y, Z axes					
SAFETY & EMC	SAFETY STANDARDS Note.6,9	UL62368-1, IEC/EN62368-1,IP65 (or IP68 for HEP-100 Blank type), EAC TP TC 004 approved ;					
	WITHSTAND VOLTAGE	I/P-O/P:3.75KVAC I/P-FG:2KVAC O/P-FG:1.5KVAC					
	ISOLATION RESISTANCE	I/P-O/P, I/P-FG, O/P-FG:100M Ohms / 500VDC / 25°C / 70% RH					
	EMC EMISSION	Compliance to EN55032 (CISPR32) Class B, EN61000-3-2,-3, EAC TP TC 020					
	EMC IMMUNITY	Compliance to EN61000-4-2,3,4,5,6,8,11, EN55024, light industry level (surge 6KV), criteria A, EAC TP TC 020					
OTHERS	MTBF	164.7K hrs min. MIL-HDBK-217F (25°C)					
	DIMENSION	220*68*38.8mm (L*W*H)					
	PACKING	1.12Kg; 12pcs/14.4Kg/0.8CUFT					
NOTE	<ol style="list-style-type: none"> 1. All parameters NOT specially mentioned are measured at 230VAC input, rated load and 25°C of ambient temperature. 2. Ripple & noise are measured at 20MHz of bandwidth by using a 12" twisted pair-wire terminated with a 0.1uf & 47uf parallel capacitor. 3. Tolerance : includes set up tolerance, line regulation and load regulation. 4. Derating may be needed under low input voltages. Please check the static characteristics for more details. 5. A type only. 6. Safety and EMC design refer to EN60598-1, CNS15233, GB7000.1, FCC part18. 7. Length of set up time is measured at cold first start. Turning ON/OFF the power supply may lead to increase of the set up time. 8. The power supply is considered as a component that will be operated in combination with final equipment. Since EMC performance will be affected by the complete installation, the final equipment manufacturers must re-qualify EMC Directive on the complete installation again. 9. The water protection level test for the IP68 rating is performed 1000mm below the surface of the water for 1 month. 10. The ambient temperature derating of 3.5°C/1000m with fanless models and of 5°C/1000m with fan models for operating altitude higher than 2000m(6500ft). 						



100W Enclosed type single output power supply > HEP-100

Block Diagram

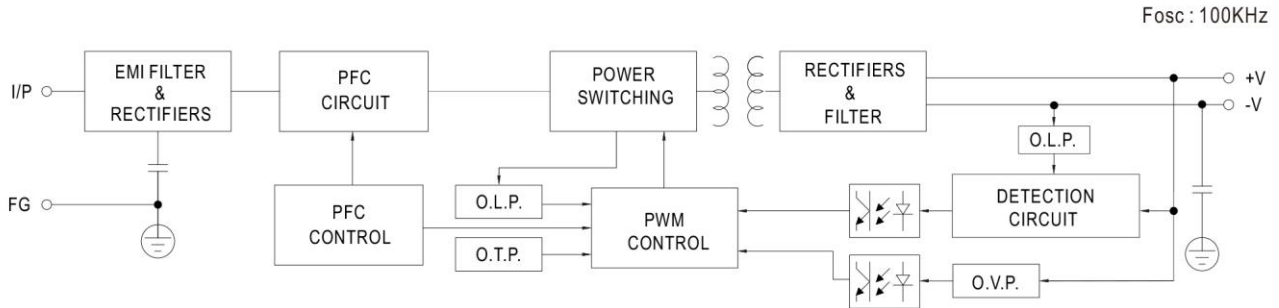

Derating Curve

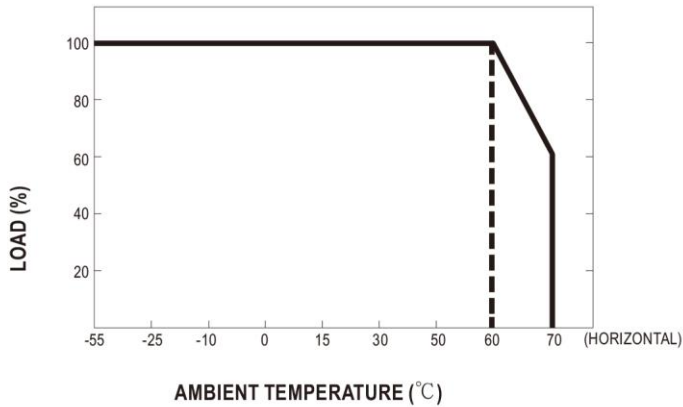

Static Characteristics

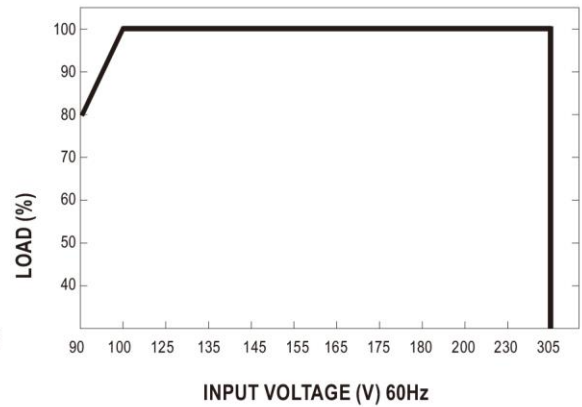



100W Enclosed type single output power supply > HEP-100

Mechanical Specification

Case No.994A Unit:mm

A Type: HEP-100-_A(standard model)

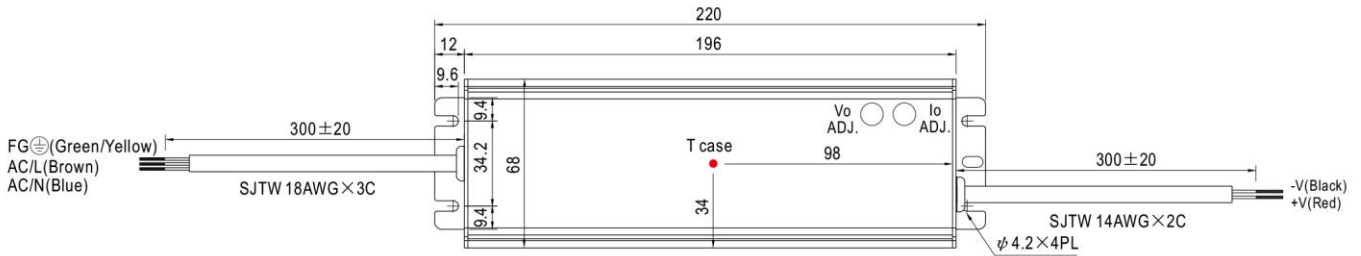

※ T case: Max. Case Temperature.

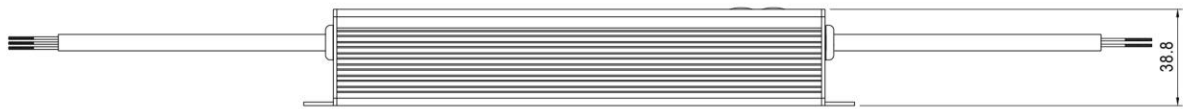

※ IP65 rated. Output voltage and constant current level can be adjusted through internal potentiometer.
 (Can access by removing the rubber stopper on the case.)

Blank: HEP-100(optional model)

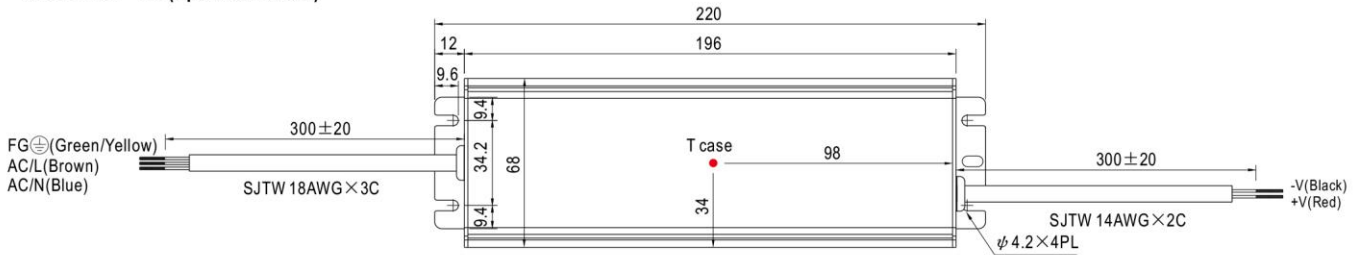

※ T case: Max. Case Temperature.



※ IP68 rated. Cable for I/O connection.