



12W Wall Mount interchangeable Medical power supply > GEM12I



(Cable connection)



(USB connection)



(except for GEM12I05-USB)



Features

- Interchangeable AC plugs (plug kit sold sperately)
- Medical safety approved (2 x MOPP) accroding to ANSI/AAMI ES60601-1/ES60601-1-11,EN60601-1/EN60601-1-11
- Extremely low leakage current
- No load power consumption< 0.075W(<0.1W for 18V/48V)
- **Energy efficiency Level VI**
- -20~+70°C wide range working temperature
- Class II power (no earth pin)
- Protections: Short circuit / Overload / Over voltage
- Fully enclosed plastic case
- 3 years warranty

Applications

- Blood glucose meter
- Blood pressure meter
- Nebulizer
- Inhaler
- Portable medical device
- Sleep apnea devices

Description

GEM12I is a highly reliable, 12W wall-mounted style single-output green medical adaptor series, which is compact and convenient for carry. This product is equipped with an interchangeable AC plug (4 types, including European type, USA type, U.K. type and Australian type) that makes it very suitable for businessmen to use in the major countries around the globe. GEM12I is a class II power unit (no FG), accepting the input range from 80VAC to 264VAC that it can satisfy the demands for various types of medical electrical devices. The circuitry design meets the international medical standards (2*MOPP), having an ultra low leakage current (<100µA), fitting the medical devices in direct electrical contact with the patients.

With the working efficiency up to 87% and the extremely low no-load power consumption below 0.075W, GEM12I is compliant with the latest USA energy regulation EISA 2007/DoE(Level VI) and EU ErP. The supreme feature allows the adaptor to save the energy when it is under either the operating mode or the standby mode. The entire series is approved for international safety regulations; moreover, it adopts the 94V-0 flame retardant plastic case that it can effectively prevent users from electric hazard.

Model Encoding

GEM12 I 05 -P1J

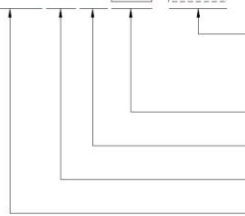

DC plug type { P1J: Plug for standard model, 2.1ψ × 5.5ψ × 11mm,
 C+ tuning fork type
 USB: USB(type A) for 5V model only
 Other option available by customer requested (See page 4~5)



12W Wall Mount interchangeable Medical power supply > GEM12I

Interchangeable AC plug Specifically for GEM06/12/18/30/40/60I

TYPE					
	Australian type	U.K type	European type	US type	Mix four type
ORDER NO.	AC plug-AU2	AC plug-UK2	AC plug-EU2	AC plug-US2	AC plug-MIX2

SPECIFICATION

ORDER NO.	GEM12I05- <input type="checkbox"/> P1J <input type="checkbox"/> USB	GEM12I07-P1J	GEM12I09-P1J	GEM12I12-P1J	GEM12I15-P1J	GEM12I18-P1J	GEM12I24-P1J	GEM12I48-P1J		
OUTPUT	SAFETY MODEL NO.	GEM12I05	GEM12I07	GEM12I09	GEM12I12	GEM12I15	GEM12I18	GEM12I24	GEM12I48	
	DC VOLTAGE Note.2	5V	7.5V	9V	12V	15V	18V	24V	48V	
	RATED CURRENT	2.4A	1.6A	1.33A	1A	0.8A	0.66A	0.5A	0.25A	
	CURRENT RANGE	0 ~ 2.4A	0 ~ 1.6A	0 ~ 1.33A	0 ~ 1A	0 ~ 0.8A	0 ~ 0.66A	0 ~ 0.5A	0 ~ 0.25A	
	RATED POWER (max.)	12W	12W	12W	12W	12W	12W	12W	12W	
	RIPPLE & NOISE (max.) Note.3	60mVp-p	60mVp-p	60mVp-p	80mVp-p	80mVp-p	80mVp-p	80mVp-p	100mVp-p	
	VOLTAGE TOLERANCE Note.4	±5.0%	±5.0%	±4.0%	±3.0%	±3.0%	±3.0%	±2.0%	±2.0%	
	LINE REGULATION Note.5	±1.0%	±1.0%	±1.0%	±1.0%	±1.0%	±1.0%	±1.0%	±1.0%	
	LOAD REGULATION Note.6	±5.0%	±5.0%	±4.0%	±3.0%	±3.0%	±3.0%	±2.0%	±2.0%	
	SETUP, RISE, HOLD UP TIME	500ms, 30ms, 16ms/230VAC 500ms, 30ms, 16ms/115VAC at full load								
INPUT	VOLTAGE RANGE Note.7	80 ~ 264VAC		113 ~ 370VDC						
	FREQUENCY RANGE	47 ~ 63Hz								
	EFFICIENCY (Typ.)	80%	82%	82%	82.5%	84%	85%	85%	87%	
	AC CURRENT	0.4A / 115VAC 0.2A / 230VAC								
	INRUSH CURRENT (max.)	Cold start 30A / 115VAC 60A / 230VAC								
PROTECTION	LEAKAGE CURRENT(max.)	Touch current < 100µA/264VAC								
	OVERLOAD	110 ~ 200% rated output power Protection type : Hiccup mode, recovers automatically after fault condition is removed								
	OVER VOLTAGE	110 ~ 140% rated output voltage Protection type : Clamp by zener diode, output short								
ENVIRONMENT	WORKING TEMP.	-20 ~ +70°C (Refer to "Derating Curve")								
	WORKING HUMIDITY	20% ~ 90% RH non-condensing								
	STORAGE TEMP., HUMIDITY	-20 ~ +85°C, 10 ~ 95% RH non-condensing								
	TEMP. COEFFICIENT	±0.03% / °C (0 ~ 40°C)								
SAFETY & EMC (Note. 8)	VIBRATION	10 ~ 500Hz, 2G 10min./1cycle, period for 60min. each along X, Y, Z axes								
	SAFETY STANDARDS	TUV EN60601-1/EN60601-1-11, ANSI/AAMI ES60601-1/ES60601-1-11(3.1 version), CAN/CSA-C22 NO. 60601-1 3 rd edition, EAC TP TC 004 approved GEM12I05-USB without EN60601-1-11, ANSI/AAMII ES60601-1-11								
	ISOLATION LEVEL	Primary - Secondary: 2 x MOPP								
	WITHSTAND VOLTAGE	I/P-O/P:5656VDC								
	ISOLATION RESISTANCE	I/P-O/P:100M Ohms / 500VDC / 25°C/ 70% RH								
	EMC EMISSION	Parameter	Standard				Test Level / Note			
		Conducted emission	EN55011 (CISPR11), FCC PART 15 / CISPR22				Class B			
		Radiated emission	EN55011 (CISPR11), FCC PART 15 / CISPR22				Class B			
		Harmonic current	EN61000-3-2				Class A			
	Voltage flicker	EN61000-3-3				-----				
	EMC IMMUNITY	EN60601-1-2, EN61204-3								
		Parameter	Standard				Test Level / Note			
		ESD	EN61000-4-2				Level 4, 15KV air ; Level 4, 8KV contact			
		RF field susceptibility	EN61000-4-3				Level 3, 10V/m(80MHz~2.7GHz) Table 9, 9~28V/m(385MHz~5.78GHz)			
		EFT bursts	EN61000-4-4				Level 3, 2KV			
Surge susceptibility		EN61000-4-5				Level 3, 1KV/Line-Line				
Conducted susceptibility		EN61000-4-6				Level 2, 3V				
Magnetic field immunity		EN61000-4-8				Level 4, 30A/m				
Voltage dip, interruption	EN61000-4-11				>95% dip 0.5 periods, 30% dip 25 periods, >95% interruptions 250 periods					
OTHERS	LIFE	3 years : 100% load 40°C, 12hours / day								
	MTBF	400Khrs min. MIL-HDBK-217F (25°C)								
	DIMENSION	73.9*39*48.5mm (L*W*H)								
	PACKING	115g ; 72pcs / 9.3kg / CARTON for cable connection; 78.5g ; 150pcs / 12.8kg / CARTON for USB connection								
CONNECTOR	PLUG	See page 4~5 ; other type available by customer requested								
	CABLE	See page 4~5 ; other type available by customer requested								
NOTE	1.All parameters are specified at 230VAC input, rated load, 25°C, 70% RH ambient. 2.DC voltage: The output voltage set at point measure by plug terminal & 50% load. 3.Ripple & noise are measured at 20MHz by using a 12" twisted pair terminated with a 0.1µf & 47µf capacitor. 4.Tolerance: includes set up tolerance, line regulation, load regulation. 5.Line regulation is measured from low line to high line at rated load. 6.Load regulation is measured from 10% to 100% rated load. 7.Derating may be needed under low input voltage. Please check the derating curve for more details. 8.The power supply is considered as an independent unit, but the final equipment still need to re-confirm that the whole system complies with the EMC directives. For guidance on how to perform these EMC tests, please refer to "EMI testing of component power supplies."									



12W Wall Mount interchangeable Medical power supply > GEM12I

■ Derating Curve

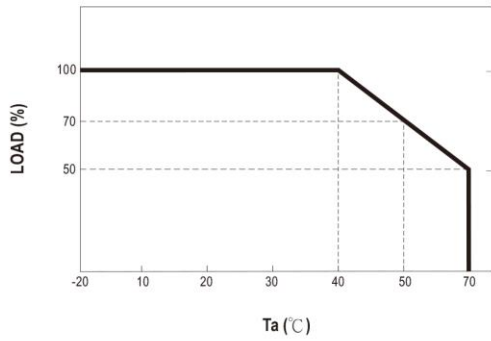

■ Static Characteristics

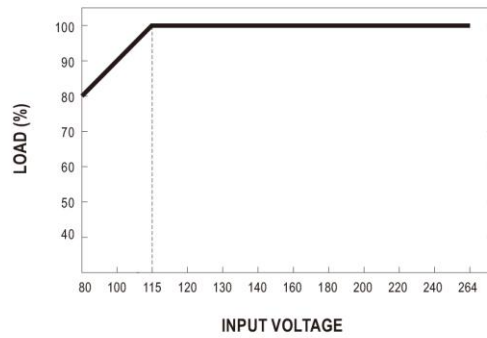

■ Mechanical Specification

Unit:mm

TYPE	Australian type	U.K type	European type	US type

※Cable connection

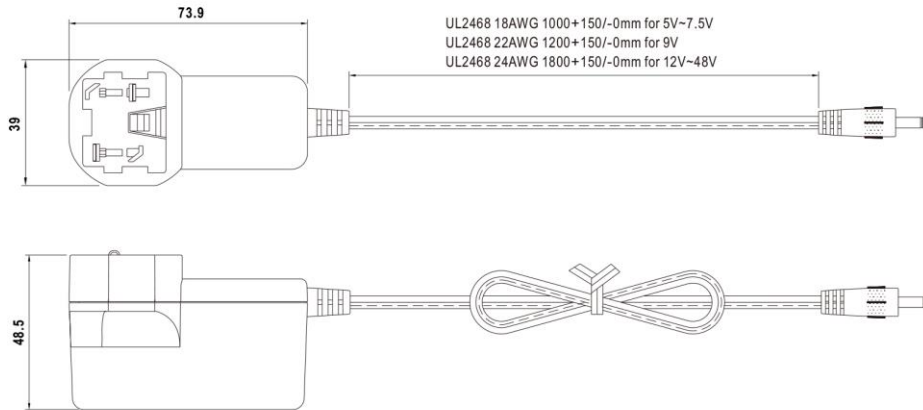

※USB connection

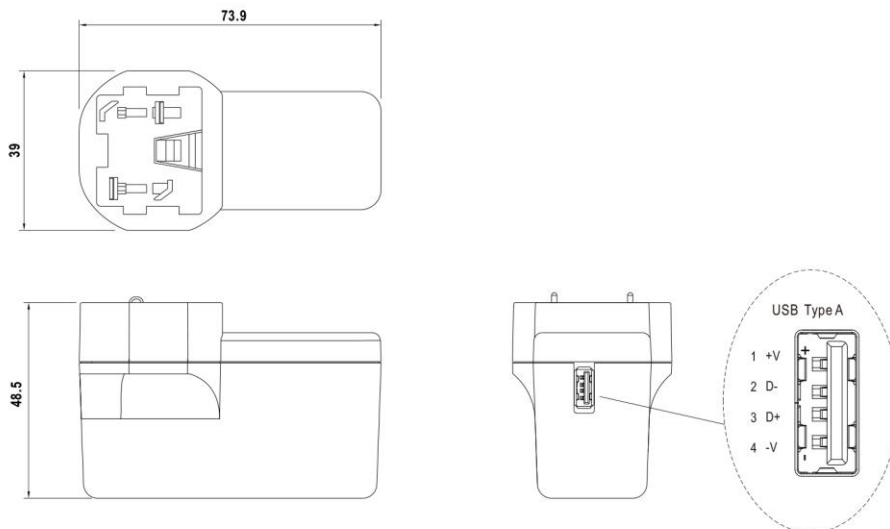

12W Wall Mount interchangeable Medical power supply > GEM12I

■ DC output plug

◎ Standard plug: P1J

Unit:mm

P1J	Pin Assignment
	Outside Inside

◎ DC plug changeable through:

- (1) Customization of the standard part with an optional DC plug according to the table (MOQ applicable)
- (2) Quick adapter accessory (sold separately without MOQ)

Example quick adapter accessory:





◎ Optional DC plug: (Available in customized cable or quick adapter)

Tuning Fork Style	Type No.	A	B	C	Quick Adapter Accessory
		OD	ID	L	
	P1I (Straight)	5.5	2.1	9.5	Available (Current rating: 7.5A max.)
	P1L (Straight)	5.5	2.5	9.5	
	P1M (Straight)	5.5	2.5	11.0	
	P1IR (Right-angled)	5.5	2.1	9.5	
	P1JR (Right-angled)	5.5	2.1	11.0	
	P1LR (Right-angled)	5.5	2.5	9.5	
	P2I (Straight)	5.5	2.1	9.5	None
	P2J (Straight)	5.5	2.1	11.0	
	P2L (Straight)	5.5	2.5	9.5	
	P2M (Straight)	5.5	2.5	11.0	
	P2IR (Right-angled)	5.5	2.1	9.5	
	P2JR (Right-angled)	5.5	2.1	11.0	
	P2S(S761K) (Floating Locking)	5.53	2.03	12.06	None
	P2K(761K)	5.53	2.54	12.06	
	P2C(S760K)	5.53	2.03	9.52	
	P2D(760K)	5.53	2.54	9.52	
	P3A	2.35	0.7	11.0	Available (Current rating: 5A max.)
	P3B	4.0	1.7	11.0	
	P3C	4.75	1.7	11.0	

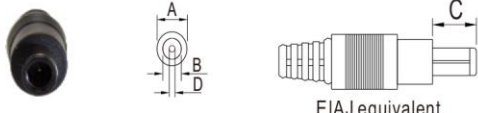
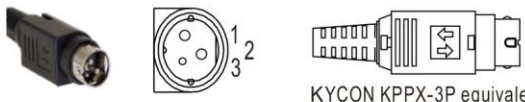

12W Wall Mount interchangeable Medical power supply > GEM12I

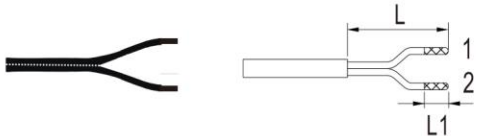
Center Pin Style	Type No.	A	B	C	D	Quick Adapter Accessory
		OD	ID	L	Center Pin	
 EIAJ equivalent	P4A	5.5	3.4	11.0	1.0	Available (Current rating: 7.5A max.)
	P4B	6.5	4.4	11.0	1.4	
	P4C	7.4	5.1	11.0	0.6	
Min. DIN 3 Pin with Lock (male)	Type No.	Pin Assignment				Available (Current rating: 7.5A max.)
 KYCON KPPX-3P equivalent		PIN No.	Output			
	R6B	1	+Vo			
		2	-Vo			
		3	+Vo			
Min. DIN 4 Pin with Lock (male)	Type No.	Pin Assignment				Available (Current rating: 7.5A max.)
 KYCON KPPX-4P equivalent		PIN No.	Output			
	R7B	1	+Vo			
		2	-Vo			
		3	-Vo			
		4	+Vo			
Min. DIN 4 Pin with Lock (female)	Type No.	Pin Assignment				None
 KYCON KPJX-CM-4S equivalent		PIN No.	Output			
	R7BF	1	+Vo			
		2	-Vo			
		3	-Vo			
		4	+Vo			
Stripped and tinned leads	Type No.	Pin Assignment				None
 Length of Land L1 by request (MW's standard length, L: <u>25</u> mm, L1: <u>10</u> mm)		PIN No.	Output			
	by customer	1 (Ribbed)	+Vo			
		2 (Letter)	-Vo			