



E-Star Power Development Co., Ltd. (E-STAR)
 1F., No.40, Juren Ln., Sec. 2, Sanmin Rd., Banciao Dist., New Taipei City
 22069, Taiwan (R.O.C.)
 Phone : 886-2-2957 5580 Fax : 886-2-2957 7473

30W Module Type Medical power supply > MPM-30



Features

- 2.73"x1.53" compact size
- Medical safety approved (2 x MOPP) according to ANSI/AAMI ES60601-1 and IEC/EN60601-1
- Suitable for BF application with appropriate system consideration
- No load power consumption < 0.075W
- Extremely low leakage current
- Wide operating temp. range -40 ~ +85°C
- EMI class B for class II configuration
- Protections: Short circuit / Overload / Over voltage
- No minimum load required
- 3 years warranty

Applications

- Portable medical device
- Mobile clinical workstation
- Medical computer monitor
- Medical examination instrument

Description

MPM-30 is a 30W high density and small size (69.5x39x24mm) AC/DC module type medical power supply series offered in pin type. It features the operation for 80~264VAC, a low no load power consumption less than 0.075W, a high efficiency up to 91%, Class II (no FG) double insulation, outstanding dissipation and high lifespan thanks to the interior potting, 5G anti-vibration, high EMC performance, 4KVAC isolation, etc. The design observes IEC/EN60601-1 and ANSI/AAMI ES60601-1 version three with 2xMOPP level and ultra-low leakage current (<80 μA). It is very suitable for BF (patient contact) type medical device or relevant equipment. In addition to PCB mounting style, MPM-30 series also offers the screw terminal style model (ST).

Model Encoding

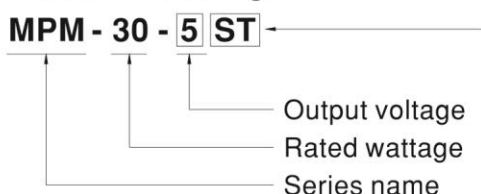

- Blank : PCB mounting style
- ST : Screw terminal style



30W Module Type Medical power supply > MPM-30

MODEL		MPM-30-3.3□	MPM-30-5□	MPM-30-12□	MPM-30-15□	MPM-30-24□	MPM-30-48□
OUTPUT	DC VOLTAGE	3.3V	5V	12V	15V	24V	48V
	RATED CURRENT	6A	6A	2.5A	2A	1.3A	0.63A
	CURRENT RANGE <small>Note.2</small>	0 ~ 6A	0 ~ 6A	0 ~ 2.5A	0 ~ 2A	0 ~ 1.3A	0 ~ 0.63A
	PEAK CURRENT	7.8A	6.9A	2.9A	2.3A	1.5A	0.73A
	RATED POWER	19.8W	30W	30W	30W	31.2W	30.2W
	PEAK LOAD(10sec.) <small>Note.3</small>	25.7W	34.5W	34.8W	34.5W	36W	35W
	RIPPLE & NOISE (max.) <small>Note.4</small>	80mVp-p	80mVp-p	120mVp-p	120mVp-p	200mVp-p	200mVp-p
	VOLTAGE TOLERANCE <small>Note.5</small>	±2.0%	±2.0%	±2.0%	±2.0%	±2.0%	±2.0%
	LINE REGULATION	±0.5%	±0.5%	±0.5%	±0.5%	±0.5%	±0.5%
	LOAD REGULATION	±1.0%	±1.0%	±0.5%	±0.5%	±0.5%	±0.5%
	SETUP, RISE TIME	500ms, 30ms/230VAC 500ms, 30ms/115VAC at full load					
HOLD UP TIME (Typ.)	40ms/230VAC 12ms/115VAC at full load						
INPUT	VOLTAGE RANGE <small>Note.6</small>	80 ~ 264VAC					
	FREQUENCY RANGE	47 ~ 63Hz					
	EFFICIENCY (Typ.)	82.5%	86.5%	90%	89%	90%	91%
	AC CURRENT (Typ.)	0.75A/115VAC 0.5A/230VAC					
	INRUSH CURRENT (Typ.)	COLD START 25A/115VAC 45A/230VAC					
	LEAKAGE CURRENT (max.) <small>Note.7</small>	Touch current <80 μ A/264VAC					
PROTECTION	OVERLOAD	115% ~ 165% rated output power Protection type : Hiccup mode, recovers automatically after fault condition is removed					
	OVER VOLTAGE	3.5 ~ 4.5V	5.3 ~ 6.8V	12.6 ~ 16.2V	15.8 ~ 20.3V	25.2 ~ 32.4V	50.4 ~ 64V
		Protection type : Shut down o/p voltage, re-power on to recover					
ENVIRONMENT	WORKING TEMP.	-40 ~ +85 $^{\circ}$ C (Refer to "Derating Curve")					
	WORKING HUMIDITY	20 ~ 90% RH non-condensing					
	STORAGE TEMP., HUMIDITY	-40 ~ +85 $^{\circ}$ C, 10 ~ 95% RH non-condensing					
	TEMP. COEFFICIENT	±0.03%/ $^{\circ}$ C (0 ~ 60 $^{\circ}$ C)					
	SOLDERING TEMPERATURE	260 $^{\circ}$ C ±5 $^{\circ}$ C/10sec.max.					
	VIBRATION	Blank:10 ~ 500Hz, 2G 10min./1cycle, period for 60min. each along X, Y, Z axes ST:10 ~ 500Hz, 5G 10min./1cycle, period for 60min. each along X, Y, Z axes					
	OPERATING ALTITUDE <small>Note.8</small>	PCB mounting: 5000 meters			Screw terminal style: 3000 meters		
SAFETY & EMC (Note 9)	SAFETY STANDARDS	IEC60601-1, EN60601-1, EAC TP TC 004, UL ANSI/AAMI ES60601-1(3.1 version), CAN/CSA-C22 3 rd Edition approved; Design refer to EN60335-1					
	ISOLATION LEVEL	Primary-Secondary: 2xMOPP					
	WITHSTAND VOLTAGE	I/P-O/P:4KVAC					
	ISOLATION RESISTANCE	I/P-O/P:100M Ohms / 500VDC / 25 $^{\circ}$ C / 70% RH					
	EMC EMISSION	Parameter		Standard		Test Level / Note	
		Conducted		EN55011 (CISPR11)		Class B	
		Radiated		EN55011 (CISPR11)		Class B	
		Harmonic Current		EN61000-3-2		Class A	
		Voltage Flicker		EN61000-3-3		-----	
	EMC IMMUNITY	EN60601-1-2					
		Parameter		Standard		Test Level / Note	
		ESD		EN61000-4-2		Level 4, 15KV air ; Level 4, 8KV contact	
		RF field susceptibility		EN61000-4-3		Level 3, 10V/m(80MHz~2.7GHz) Table 9, 9~28V/m(385MHz~5.78GHz)	
		EFT bursts		EN61000-4-4		Level 3, 2KV	
		Surge susceptibility		EN61000-4-5		Level 3, 1KV/Line-Line	
Conducted susceptibility		EN61000-4-6		Level 3, 10V			
Magnetic field immunity		EN61000-4-8		Level 4, 30A/m			
Voltage dip, interruption		EN61000-4-11		100% dip 1 periods, 30% dip 25 periods, 100% interruptions 250 periods			
OTHERS	MTBF	779Khrs min. MIL-HDBK-217F (25 $^{\circ}$ C)					
	DIMENSION	PCB mounting style:69.5*39*24mm (L*W*H) or 2.73**1.53**0.94" inch				Screw terminal style:91*39.5*28.5mm (L*W*H) or 3.58**1.55**1.12" inch	
	PACKING	PCB mounting style:0.102Kg;144pcs/15.7Kg/0.97CUFT				Screw terminal style :0.12Kg;120pcs/14.9Kg/0.74CUFT	
NOTE	<ol style="list-style-type: none"> All parameters NOT specially mentioned are measured at 230VAC input, rated load and 25$^{\circ}$C of ambient temperature. No minimum load required. 33% Duty cycle maximum within every 30 seconds. Average output power should not exceed the rated power. Ripple & noise are measured at 20MHz of bandwidth by using a 12" twisted pair-wire terminated with a 0.1 μf & 47 μf parallel capacitor. Tolerance : includes set up tolerance, line regulation and load regulation. Derating may be needed under low input voltages. Please check the derating curve for more details. Touch current was measured from primary input to DC output. The ambient temperature derating of 3.5$^{\circ}$C/1000m with fanless models and of 5$^{\circ}$C/1000m with fan models for operating altitude higher than 2000m(6500ft). The power supply is considered a component which will be installed into a final equipment. The final equipment must be re-confirmed that it still meets EMC directives. For guidance on how to perform these EMC tests, please refer to "EMI testing of component power supplies." 						



30W Module Type Medical power supply > MPM-30

Block Diagram

fosc : 65KHz

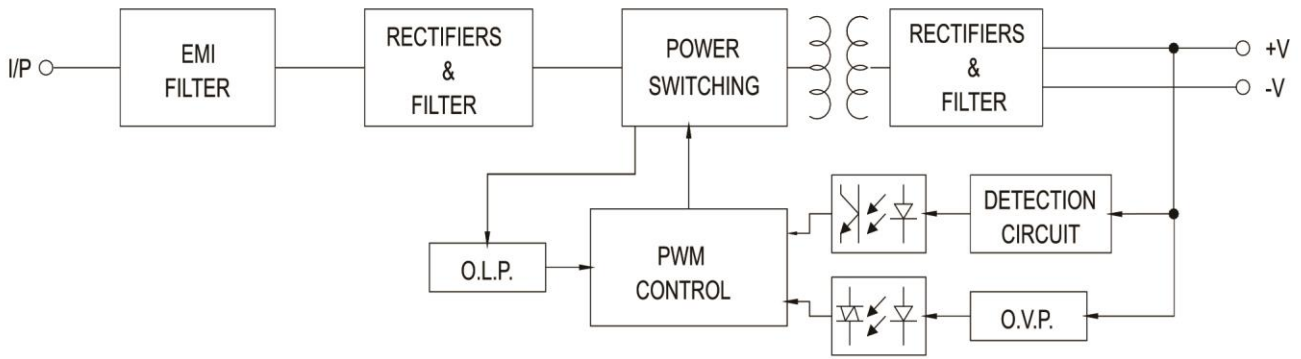

Derating Curve

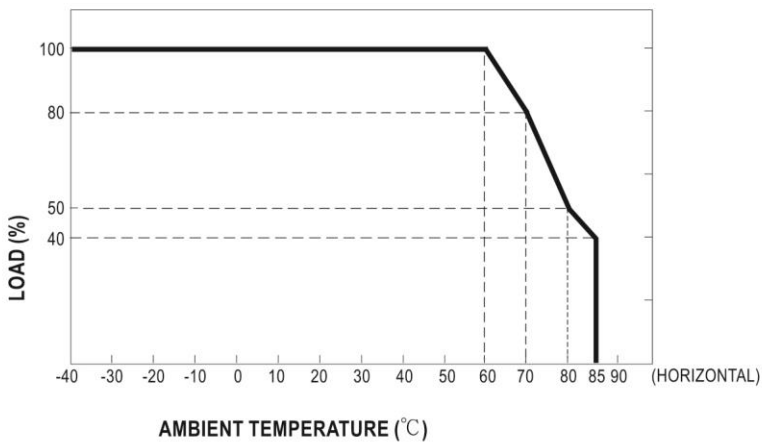

Output Derating VS Input Voltage

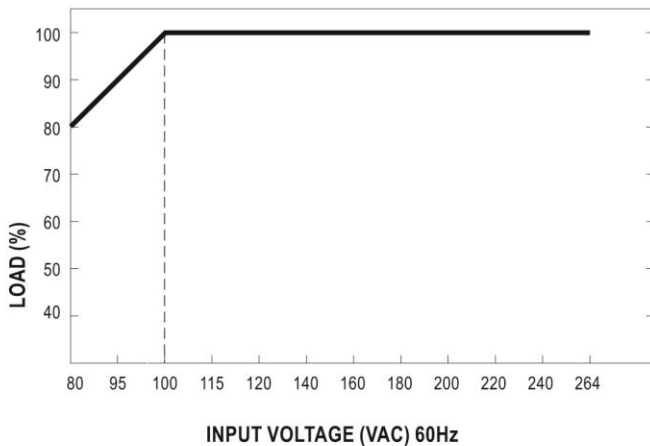



30W Module Type Medical power supply > MPM-30

Mechanical Specification

Case No. Unit:mm

- MPM-30 (PCB mounting style)

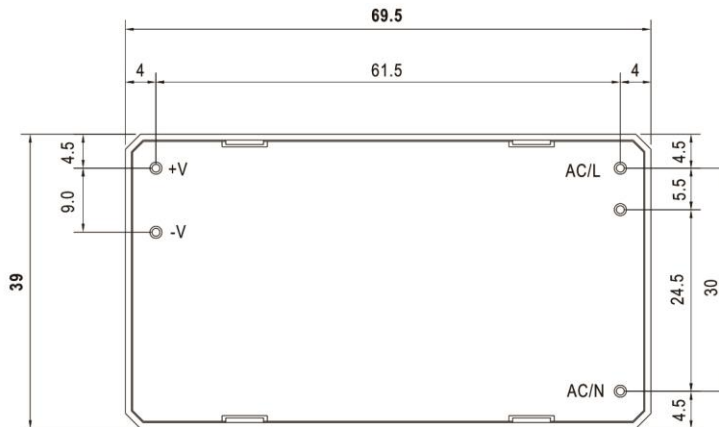

BOTTOM VIEW

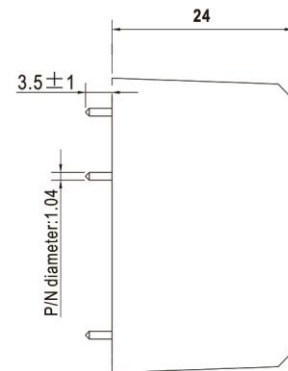

SIDE VIEW

- MPM-30-ST (Screw terminal style)

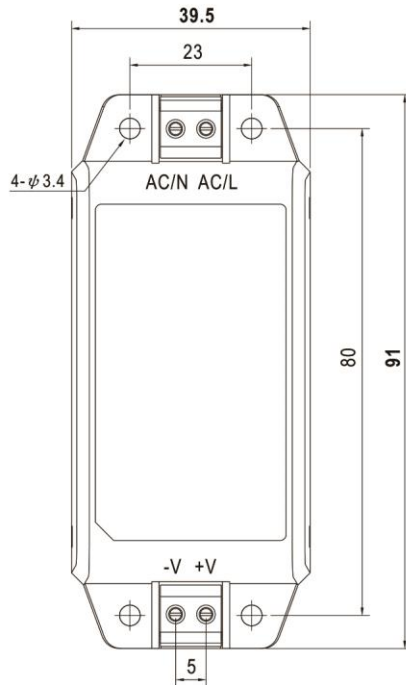

TOP VIEW

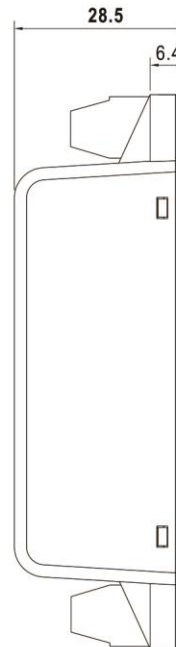

SIDE VIEW