



E-Star Power Development Co., Ltd. (E-STAR)  
 1F., No.40, Juren Ln., Sec. 2, Sanmin Rd., Banciao Dist., New Taipei City  
 22069, Taiwan (R.O.C.)  
 Phone : 886-2-2957 5580 Fax : 886-2-2957 7473

**75W LED Driver power supply < XLG-75**



**Features**

- Wide input range 100~305V AC( Class I )
- Full power output at 70~100% Constant power mode operation
- Metal case with IP67, suitable for outdoor application
- Class 2 power unit(except for L type)
- Surge protection with 6KV/4KV (10KV/6KV optional)
- 3 in 1 dimming function (Dim to off and Isolation design)
- India (EESL) version with Input Over Voltage Protection can survive input voltage stress of 440Vac for 48 hours
- Protection functions: OVP/SCP/OC/OTP
- Life time >50,000 hrs. and 5 years warranty

**Applications**

- Skyscraper lighting
- Street lighting
- Floodlight Lighting
- Stage lighting
- Fishing lighting
- Horticulture lighting
- Bay lighting
- DMX power supply
- Type HL for use in class I , Division 2

**Description**

XLG-75 series is a 75W LED AC/DC driver featuring the constant power mode. XLG-75 operates from 100~305VAC and offers models with different rated current ranging between 700mA and 5000mA. Thanks to the high efficiency up to 91%, with the fanless design, the entire series is able to operate for -40°C~+90°C case temperature under free air convection. The design of metal housing and IP67 ingress protection level allows this series to fit both indoor and outdoor applications. Moreover the innovative environment-adaptive capability allows this series to reliably light on the LEDs for all kinds of application environments in almost any spots that may install LED luminaires in the world. XLG-75 series comply with the latest version of IEC61347/GB7000.1-2015 and UL8750 international safety regulations. The output and dimming circuit are also completely in accordance with the new regulations with isolation to ensure the safety of both user and luminaire system during installation.

**Model Encoding**

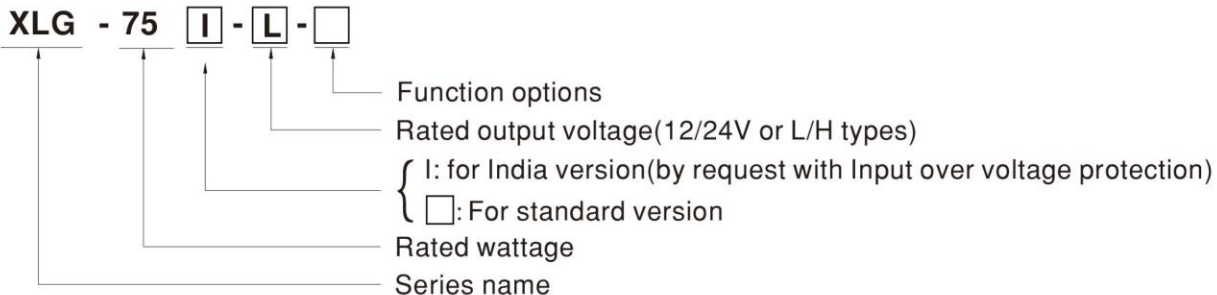

Type	Function	Note
Blank	Io and Vo fixed.(For harsh environment)	By request
A	Io adjustable via built-in potentiometer	In Stock
AB	Io adjustable via built-in potentiometer + 3 in 1 dimming function (0~10Vdc, 10V PWM signal and resistance)	In Stock

Note: 12V and 24V models without the AB type



**75W LED Driver power supply < XLG-75**

**SPECIFICATION**

MODEL		XLG-75□-12-□	XLG-75□-24-□	
OUTPUT	DC VOLTAGE	12V	24V	
	CONSTANT CURRENT REGION <small>Note.2</small>	8.4~ 12V	16.8~ 24V	
	RATED CURRENT	5A	3.1A	
	RATED POWER	60W	74.4W	
	RIPPLE & NOISE (max.) <small>Note.3</small>	150mVp-p	240mVp-p	
	CURRENT ADJ RANGE	2.5A~5A	1.55A~3.1A	
	VOLTAGE TOLERANCE <small>Note.4</small>	±3.0%	±2.0%	
	LINE REGULATION	±0.5%	±0.5%	
	LOAD REGULATION	±2%	±1%	
	SETUP, RISE TIME <small>Note.6</small>	500ms, 100ms/230VAC, 1200ms, 100ms/115VAC		
HOLD UP TIME (Typ.)	10ms/ 230VAC 10ms/ 115VAC			
INPUT	VOLTAGE RANGE <small>Note.5</small>	100 ~ 305VAC 142 ~ 431VDC (Please refer to "STATIC CHARACTERISTIC" section)		
	FREQUENCY RANGE	47 ~ 63Hz		
	POWER FACTOR	PF ≥ 0.97/115VAC, PF ≥ 0.95/230VAC, PF ≥ 0.92/277VAC@full load		
	TOTAL HARMONIC DISTORTION	THD < 10% (@load ≥ 50%/115VAC, 230VAC; @load ≥ 75%/277VAC)		
	EFFICIENCY (Typ.)	89%	90%	
	AC CURRENT	1.0A / 115VAC 0.45A / 230VAC 0.38A/277VAC		
	INRUSH CURRENT(Typ.)	COLD START 50A(twidth=300µs measured at 50% Ipeak) at 230VAC; Per NEMA 410		
	MAX. No. of PSUs on 16A CIRCUIT BREAKER	9 units (circuit breaker of type B) / 14 units (circuit breaker of type C) at 230VAC		
	LEAKAGE CURRENT	<0.75mA / 277VAC		
	NO LOAD POWER CONSUMPTION	No load power consumption <0.5W(for standard version)		
PROTECTION	OVER CURRENT	95 ~ 108% Hiccup mode or Constant current limiting, recovers automatically after fault condition is removed		
	SHORT CIRCUIT	Hiccup mode or Constant current limiting, recovers automatically after fault condition is removed		
	OVER VOLTAGE	13 ~ 19V	26 ~ 36V	
	INPUT OVER VOLTAGE <small>Note.7</small>	320 ~ 370VAC (Shut down output voltage when the input voltage exceeds protection voltage, recovers automatically after fault condition is removed) can survive input voltage stress of 440Vac for 48 hours		
	OVER TEMPERATURE	Shut down output voltage, re-power on to recover		
	WORKING TEMP.	Tcase=-40 ~ +90°C (Please refer to " OUTPUT LOAD vs TEMPERATURE" section)		
ENVIRONMENT	MAX. CASE TEMP.	Tcase=+90°C		
	WORKING HUMIDITY	20 ~ 95% RH non-condensing		
	STORAGE TEMP., HUMIDITY	-40 ~ +90°C, 10 ~ 95% RH		
	TEMP. COEFFICIENT	±0.03%/°C (0 ~ 60°C)		
	VIBRATION	10 ~ 500Hz, 5G 12min./1cycle, period for 72min. each along X, Y, Z axes		
	EMC SAFETY &	SAFETY STANDARDS <small>Note.7</small>	UL8750(type"HL"), UL879, CSA C22.2 No. 250.13-12; ENEC EN61347-1, EN61347-2-13 independent, EN62384; GB19510.1, GB19510.14; EAC TP TC 004; IS15885(Part2/Sec13)(for XLG-75I type only); IP67 approved	
WITHSTAND VOLTAGE		I/P-O/P:3.75KVAC I/P-FG:2KVAC O/P-FG:1.5KVAC		
ISOLATION RESISTANCE		I/P-O/P, I/P-FG, O/P-FG:100M Ohms / 500VDC / 25°C / 70% RH		
EMC EMISSION		Parameter	Standard	Test Level/Note
		Conducted	EN55015(CISPR15), GB/T17743	-----
		Radiated	EN55015(CISPR15), GB/T17743	-----
		Harmonic Current	EN61000-3-2, GB/T17625.1	Class C @load ≥ 50%
EMC IMMUNITY		Parameter	Standard	Test Level/Note
		ESD	EN61000-4-2	Level 3, 8KV air; Level 2, 4KV contact
		Radiated	EN61000-4-3	Level 3
	EFT/Burst	EN61000-4-4	Level 3	
	Surge	EN61000-4-5	4KV/Line-Line 6KV/Line-Earth(6K/10K option)	
	Conducted	EN61000-4-6	Level 3	
	Magnetic Field	EN61000-4-8	Level 4	
	Voltage Dips and Interruptions	EN61000-4-11	>95% dip 0.5 periods, 30% dip 25 periods, >95% interruptions 250 periods	
OTHERS	MTBF	1232.28K hrs min. Telcordia SR-332 (Bellcore); 376.3Khrs min. MIL-HDBK-217F (25°C)		
	DIMENSION	140*63*32mm (L*W*H)		
	PACKING	0.58Kg/24pcs /15Kg /0.85CUFT		
NOTE	<p>1. All parameters NOT specially mentioned are measured at 230VAC input, rated current and 25°C of ambient temperature.          2. Please refer to "DRIVING METHODS OF LED MODULE".          3. Ripple &amp; noise are measured at 20MHz of bandwidth by using a 12" twisted pair-wire terminated with a 0.1µf &amp; 47µf parallel capacitor.          4. Tolerance : includes set up tolerance, line regulation and load regulation.          5. De-rating may be needed under low input voltages. Please refer to "STATIC CHARACTERISTIC" sections for details.          6. Length of set up time is measured at first cold start. Turning ON/OFF the driver may lead to increase of the set up time.          7. Input over voltage only for XLG-75 I series, and I series without UL/CSA certificate.          8. The driver is considered as a component that will be operated in combination with final equipment. Since EMC performance will be affected by the complete installation, the final equipment manufacturers must re-qualify EMC Directive on the complete installation again.          9. This series meets the typical life expectancy of &gt;50,000 hours of operation when Tcase, particularly (C) point (or TMP, per DLC), is about 75°C or less.          10. The ambient temperature derating of 3.5°C/1000m with fanless models and of 5°C/1000m with fan models for operating altitude higher than 2000m(6500ft).          11. Products sourced from the Americas regions may not have the PSE/CCC/BIS/KC logo.          12. To fulfill requirements of the latest ErP regulation for lighting fixtures, this LED drivers can only be used behind a switch without permanently connected to the mains          13. For any application note and IP water proof function installation caution, please refer our user manual before using.</p>			



E-Star Power Development Co., Ltd. (E-STAR)  
 1F., No.40, Juren Ln., Sec. 2, Sanmin Rd., Banciao Dist., New Taipei City  
 22069, Taiwan (R.O.C.)  
 Phone : 886-2-2957 5580 Fax : 886-2-2957 7473

**75W LED Driver power supply < XLG-75**

**SPECIFICATION**

MODEL		XLG-75 □-L- □	XLG-75 □-H- □	
OUTPUT	RATED CURRENT	700mA	1400mA	
	RATED POWER	75W	75W	
	CONSTANT CURRENT REGION	53 ~ 107V	27 ~ 56V	
	FULL POWER CURRENT RANGE	700~1050mA	1300~2100mA	
	OPEN CIRCUIT VOLTAGE (max.)	115V	60V	
	CURRENT ADJ. RANGE	350~1050mA	650~2100mA	
	CURRENT RIPPLE	3.0%(@rated current)		
	CURRENT TOLERANCE	±5%		
SET UP TIME		500ms/230VAC, 1200ms/115VAC		
INPUT	VOLTAGE RANGE <small>Note.5</small>	100 ~ 305VAC 142VDC ~ 431VDC (Please refer to "STATIC CHARACTERISTIC" and "DRIVING METHODS OF LED MODULE" section)		
	FREQUENCY RANGE	47 ~ 63Hz		
	POWER FACTOR (Typ.)	PF ≥ 0.97 / 115VAC, PF ≥ 0.95 / 230VAC, PF ≥ 0.92 / 277VAC at full load (Please refer to "Power Factor Characteristic" section)		
	TOTAL HARMONIC DISTORTION	THD < 10% (@ load ≥ 50% at 115VAC/230VAC, @load ≥ 75% at 277VAC) Please refer to "TOTAL HARMONIC DISTORTION (THD)" section		
	EFFICIENCY (Typ.)	91%	90%	
	AC CURRENT (Typ.)	1A / 115VAC 0.45A / 230VAC 0.38A / 277VAC		
	INRUSH CURRENT(Typ.)	COLD START 50A(twidth=300μs measured at 50% Ipeak) at 230VAC; Per NEMA 410		
	MAX. NO. of PSUs on 16A CIRCUIT BREAKER	9 unit(circuit breaker of type B) / 14 units(circuit breaker of type C) at 230VAC		
	LEAKAGE CURRENT	<0.75mA / 277VAC		
	STANDBY POWER CONSUMPTION	Standby power consumption <0.5W for AB-Type(Dimming OFF)(for standard version)		
PROTECTION	OVER POWER	110 ~ 150% Hiccup mode, recovers automatically after fault condition is removed		
	SHORT CIRCUIT	Hiccup mode or Constant current limiting, recovers automatically after fault condition is removed		
	INPUT OVER VOLTAGE <small>Note.7</small>	320 ~ 370VAC (Shut down output voltage when the input voltage exceeds protection voltage, recovers automatically after fault condition is removed) can survive input voltage stress of 440Vac for 48 hours		
	OVER TEMPERATURE	Shut down output voltage, re-power on to recovery		
ENVIRONMENT	WORKING TEMP.	Tcase=-40 ~ +90°C (Please refer to "OUTPUT LOAD vs TEMPERATURE" section)		
	MAX. CASE TEMP.	Tcase=+90°C		
	WORKING HUMIDITY	20 ~ 95% RH non-condensing		
	STORAGE TEMP., HUMIDITY	-40 ~ +80°C, 10 ~ 95% RH non-condensing		
	TEMP. COEFFICIENT	±0.03%/°C (0 ~ 60°C)		
	VIBRATION	10 ~ 500Hz, 5G 12min./1cycle, period for 72min. each along X, Y, Z axes		
SAFETY & EMC	SAFETY STANDARDS <small>Note.7</small>	UL8750(type"HL"), CSA C22.2 No. 250.13-12; ENEC EN61347-1, EN61347-2-13 independent, EN62384; GB19510.1, GB19510.14; EAC TP TC 004; IS15885(Part2/Sec13)(for XLG-75I type only); IP67 approved		
	WITHSTAND VOLTAGE	I/P-O/P:3.75KVAC I/P-FG:2KVAC O/P-FG:1.5KVAC		
	ISOLATION RESISTANCE	I/P-O/P, I/P-FG, O/P-FG:100M Ohms / 500VDC / 25°C / 70% RH		
	EMC EMISSION	Parameter	Standard	Test Level/Note
		Conducted	EN55015(CISPR15), GB/T17743	-----
		Radiated	EN55015(CISPR15), GB/T17743	-----
		Harmonic Current	EN61000-3-2, GB/T17625.1	Class C @load≥50%
		Voltage Flicker	EN61000-3-3	-----
	EMC IMMUNITY	EN61547		
		Parameter	Standard	Test Level/Note
		ESD	EN61000-4-2	Level 3, 8KV air ; Level 2, 4KV contact
		Radiated	EN61000-4-3	Level 3
		EFT/Burst	EN61000-4-4	Level 3
		Surge	EN61000-4-5	4KV/Line-Line 6KV/Line-Earth(6K/10K option)
Conducted		EN61000-4-6	Level 3	
Magnetic Field		EN61000-4-8	Level 4	
Voltage Dips and Interruptions	EN61000-4-11	>95% dip 0.5 periods, 30% dip 25 periods, >95% interruptions 250 periods		
OTHERS	MTBF	1232.28K hrs min. Telcordia SR-332 (Bellcore) ; 376.3Khrs min. MIL-HDBK-217F (25°C)		
	DIMENSION	140*63*32mm (L*W*H)		
	PACKING	0.58Kg/24pcs /15Kg /0.85CUFT		
NOTE	<p>1. All parameters NOT specially mentioned are measured at 230VAC input, rated current and 25°C of ambient temperature.          2. Please refer to "DRIVING METHODS OF LED MODULE".          3. Ripple &amp; noise are measured at 20MHz of bandwidth by using a 12" twisted pair-wire terminated with a 0.1uf &amp; 47uf parallel capacitor.          4. Tolerance : includes set up tolerance, line regulation and load regulation.          5. De-rating may be needed under low input voltages. Please refer to "STATIC CHARACTERISTIC" sections for details.          6. Length of set up time is measured at first cold start. Turning ON/OFF the driver may lead to increase of the set up time.          7.Input over voltage only for XLG-75 I series ,and I series without UL/CSA certificate.          8. The driver is considered as a component that will be operated in combination with final equipment. Since EMC performance will be affected by the complete installation, the final equipment manufacturers must re-qualify EMC Directive on the complete installation again.          9. This series meets the typical life expectancy of &gt;50,000 hours of operation when Tcase, particularly (Tc) point (or TMP, per DLC), is about 75°C or less.          10. The ambient temperature derating of 3.5°C/1000m with fanless models and of 5°C/1000m with fan models for operating altitude higher than 2000m(6500ft).          11.Products sourced from the Americas regions may not have the PSE/CCC/BIS/KC logo.          12.To fulfill requirements of the latest ErP regulation for lighting fixtures, this LED drivers can only be used behind a switch without permanently connected to the mains          13.For any application note and IP water proof function installation caution, please refer our user manual before using.</p>			



**75W LED Driver power supply < XLG-75**

**BLOCK DIAGRAM**

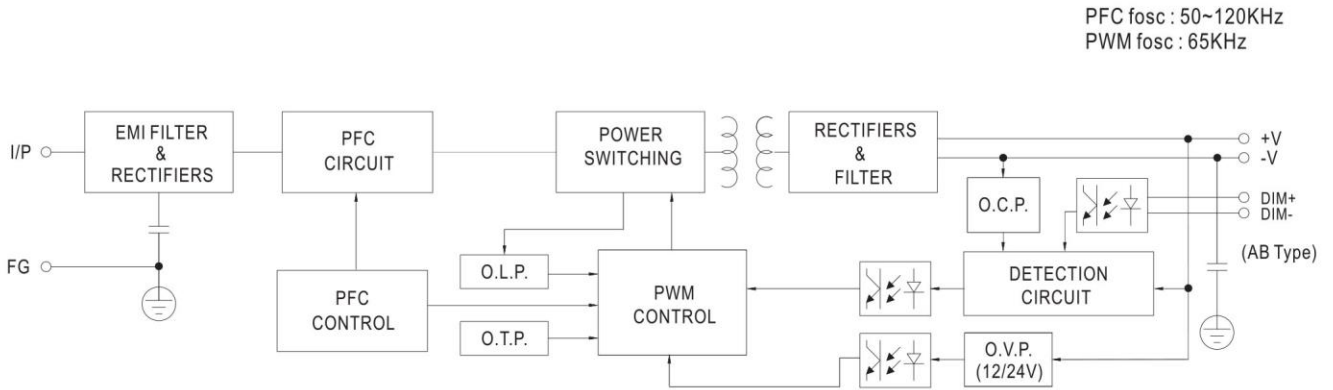

**DRIVING METHODS OF LED MODULE**

※ I-V Operating Area

◎ XLG-75-L

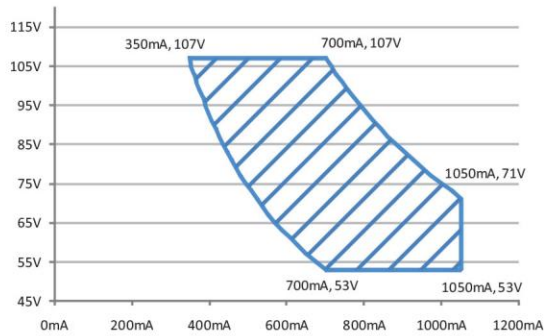

Recommend Performance Region

◎ XLG-75-H

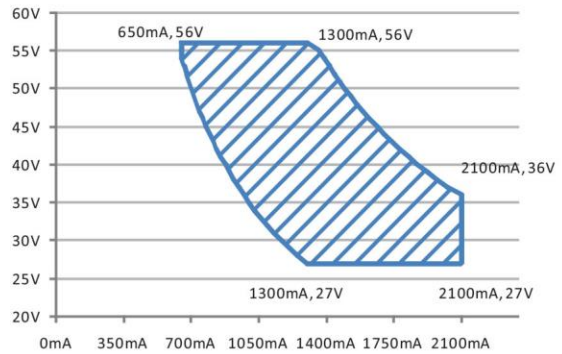

Recommend Performance Region

◎ XLG-75-12,24

※ This series is able to work in either Constant Current mode (a direct drive way) or Constant Voltage mode (usually through additional DC/DC driver) to drive the LEDs.

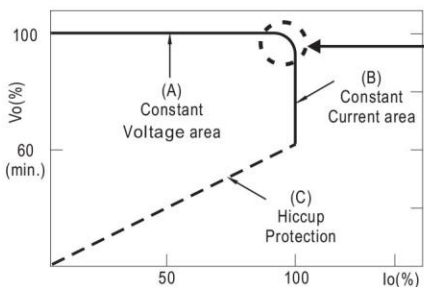

In the constant current region, the highest voltage at the output of the driver depends on the configuration of the end systems.

Typical output current normalized by rated current (%)

**75W LED Driver power supply < XLG-75**

**DIMMING OPERATION**

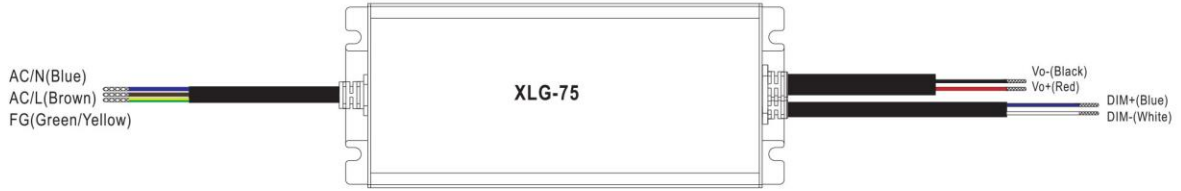

※ **3 in 1 dimming function (for AB-Type)**

- Output constant current level can be adjusted by applying one of the three methodologies between DIM+ and DIM-: 0 ~ 10VDC, or 10V PWM signal or resistance.
- Direct connecting to LEDs is suggested. It is not suitable to be used with additional drivers.
- Dimming source current from power supply: 100  $\mu$ A (typ.)

◎ Applying additive 0 ~ 10VDC

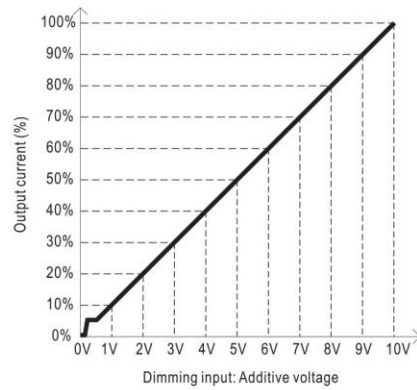
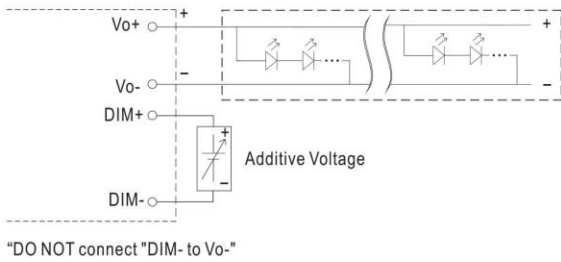

◎ Applying additive 10V PWM signal (frequency range 100Hz ~ 3KHz):

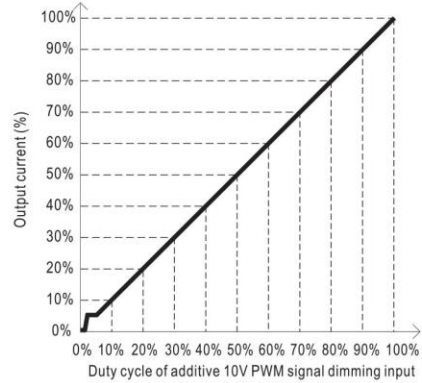
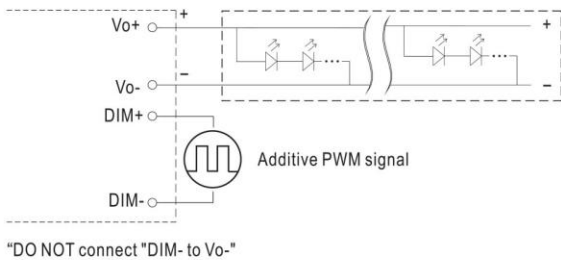

◎ Applying additive resistance:

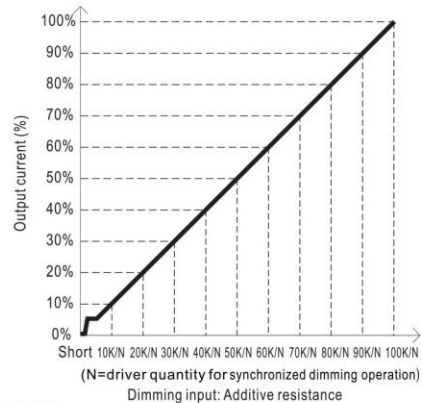
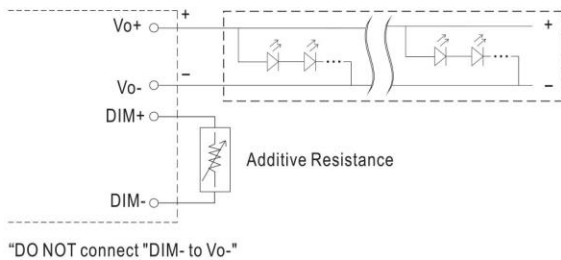

Note : 1. Min. dimming level is about 8% and the output current is not defined when 0% < Iout < 8%.  
 2. The output current could drop down to 0% when dimming input is about 0 $\Omega$  or 0Vdc, or 10V PWM signal with 0% duty cycle.



**75W LED Driver power supply < XLG-75**

**OUTPUT LOAD vs TEMPERATURE**

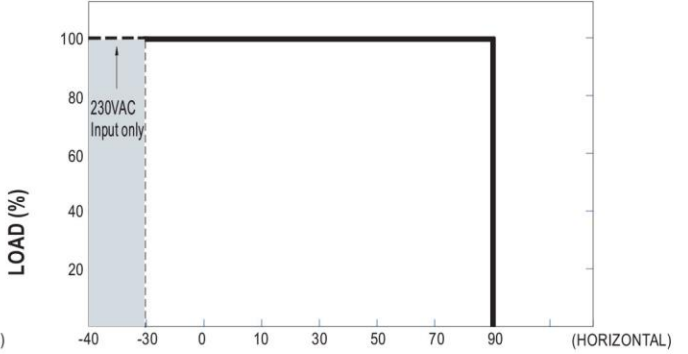
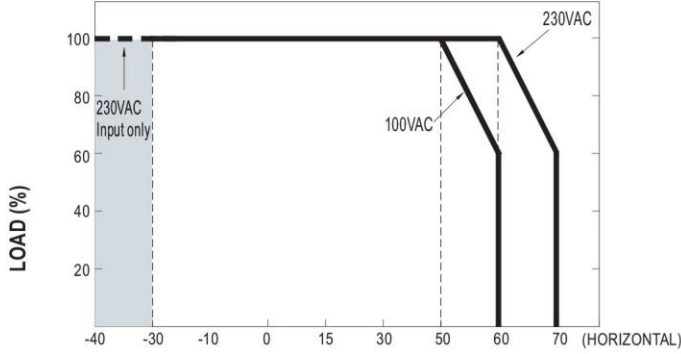

**AMBIENT TEMPERATURE, Ta (°C)**

If XLG-75 operates in Constant Current mode with the rated current the maximum workable Ta is 60°C (Typ. 230VAC) or 50°C (Typ. 100VAC)  
 Below 110VAC@ -30°C may retry to 2nd setup

**Tcase (°C)**

**STATIC CHARACTERISTIC**

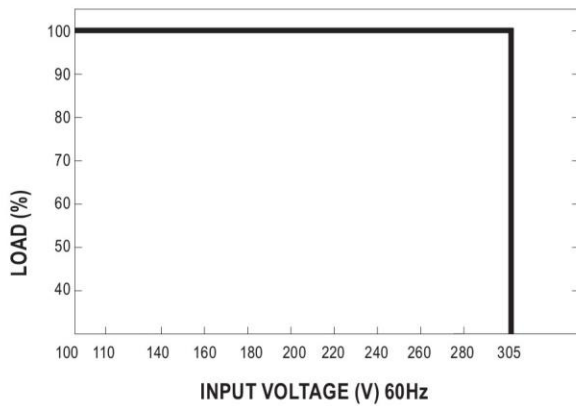

**POWER FACTOR (PF) CHARACTERISTIC**

※ Tcase at 75°C

**Constant Current Mode**

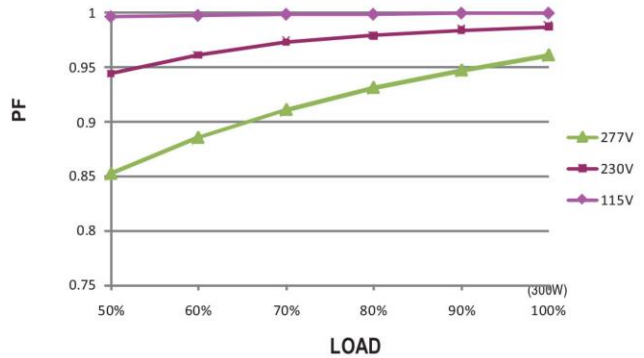

**TOTAL HARMONIC DISTORTION (THD)**

※ XLG-75-L Model, Tcase at 75°C

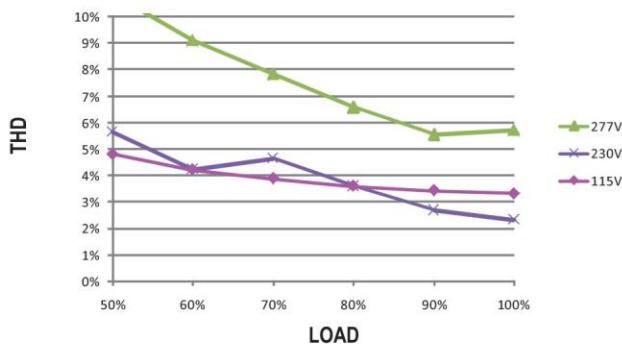

**EFFICIENCY vs LOAD**

XLG-75 series possess superior working efficiency that up to 92% can be reached in field applications.

※ XLG-75-L Model, Tcase at 75°C

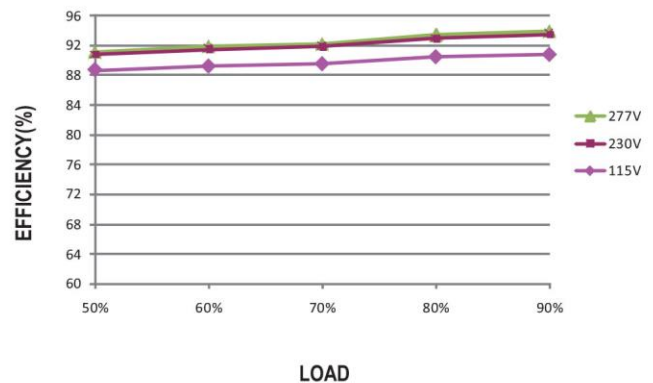



E-Star Power Development Co., Ltd. (E-STAR)  
1F, No.40, Juren Ln., Sec. 2, Sanmin Rd., Banciao Dist., New Taipei City  
22069, Taiwan (R.O.C.)  
Phone : 886-2-2957 5580 Fax : 886-2-2957 7473

**75W LED Driver power supply < XLG-75**

■ LIFE TIME

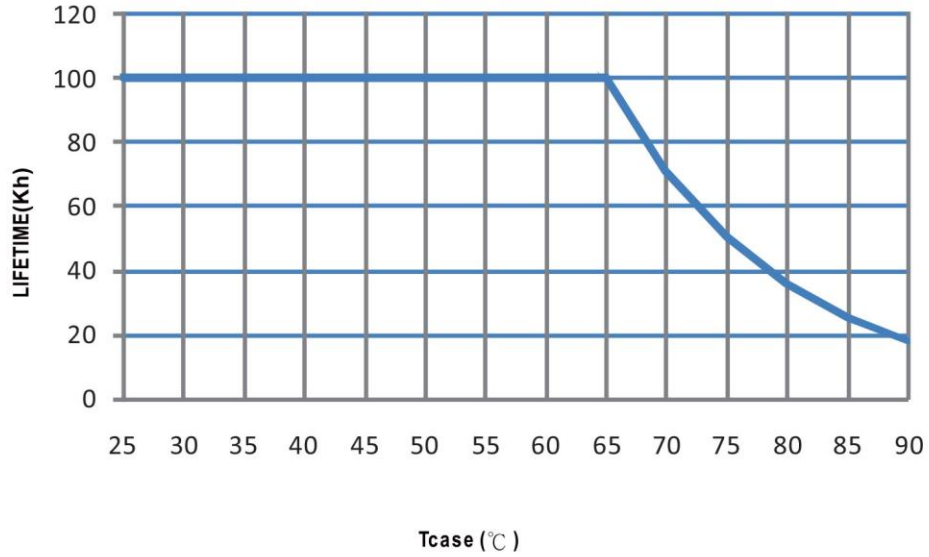



**75W LED Driver power supply < XLG-75**

**MECHANICAL SPECIFICATION**

Case No.: 275A Unit:mm

※ Blank-Type

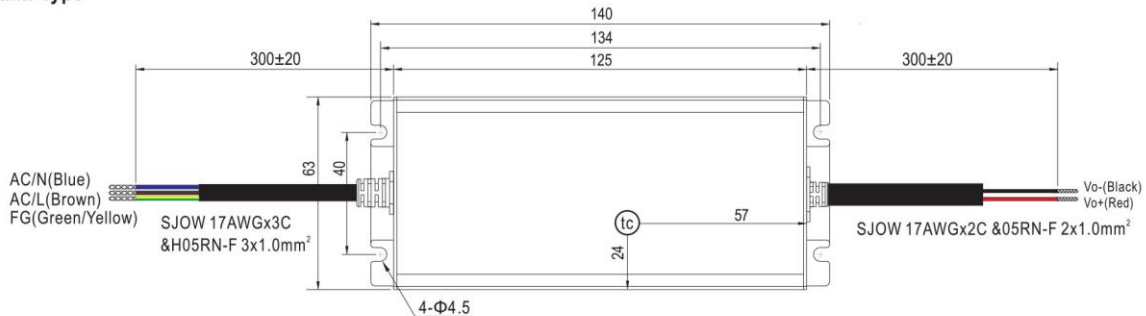

• (tc) : Max. Case Temperature



※ A-Type

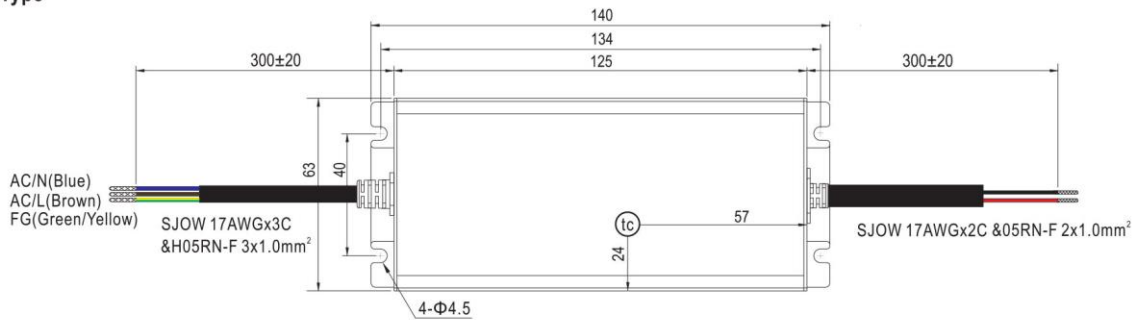

• (tc) : Max. Case Temperature







E-Star Power Development Co., Ltd. (E-STAR)  
1F., No.40, Juren Ln., Sec. 2, Sanmin Rd., Banciao Dist., New Taipei City  
22069, Taiwan (R.O.C.)  
Phone : 886-2-2957 5580 Fax : 886-2-2957 7473

**75W LED Driver power supply < XLG-75**

**MECHANICAL SPECIFICATION**

Case No.: 275A Unit:mm

※ AB-Type

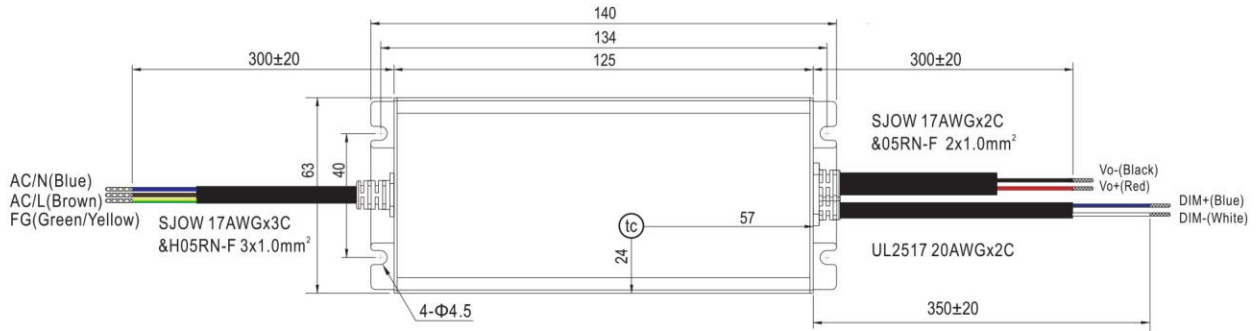

• tc : Max. Case Temperature

