



E-Star Power Development Co., Ltd. (E-STAR)  
 1F, No.40, Juren Ln., Sec. 2, Sanmin Rd., Banciao Dist., New Taipei City  
 22069, Taiwan (R.O.C.)  
 Phone : 886-2-2957 5580 Fax : 886-2-2957 7473

**100W LED Driver power supply < HVG-100**



IP65 IP67 (PFC) Type HL (for 42V,48V,54V only) cULus Type HL (except for 42V,48V,54V) FC

**Features**

- Wide input range 180 ~ 528VAC
- Constant Voltage + Constant Current mode output
- Metal housing with Class I design
- Built-in active PFC function
- IP67 / IP65 rating for indoor or outdoor installations
- Function options: output adjustable via potentiometer; 3 in 1 dimming (dim-to-off); Timer dimming
- Typical lifetime>50000 hours
- 5 years warranty

**Applications**

- LED street lighting
- LED high-bay lighting
- Parking space lighting
- LED fishing lamp
- LED greenhouse lighting
- Type "HL" for use in Class I , Division 2 hazardous (Classified) location.

**Description**

HVG-100 series is a 100W AC/DC LED driver featuring the dual mode constant voltage and constant current output. HVG-100 operates from 180~528VAC and offers models with different rated voltage ranging between 15V and 54V. Thanks to the high efficiency up to 91%, with the fanless design, the entire series is able to operate for -40°C ~ +90°C case temperature under free air convection. The design of metal housing and IP67/IP65 ingress protection level allows this series to fit both indoor and outdoor applications. HVG-100 is equipped with various function options, such as dimming methodologies, so as to provide the optimal design flexibility for LED lighting system.

**Model Encoding**

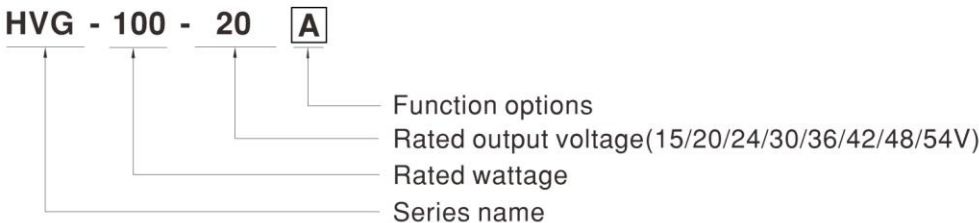

Type	IP Level	Function	Note
A	IP65	Io and Vo adjustable through built-in potentiometer.	In Stock
B	IP67	3 in 1 dimming function (0~10Vdc, 10V PWM signal and resistance)	In Stock
D	IP67	Built-in Smart timer dimming function by user request.	By request



**100W LED Driver power supply < HVG-100**

**SPECIFICATION**

MODEL		HVG-100-15	HVG-100-20	HVG-100-24	HVG-100-30	HVG-100-36	HVG-100-42	HVG-100-48	HVG-100-54	
OUTPUT	DC VOLTAGE	15V	20V	24V	30V	36V	42V	48V	54V	
	CONSTANT CURRENT REGION Note.4	9~15V	10~20V	12~24V	15~30V	18~36V	21~42V	24~48V	27~54V	
	RATED CURRENT	5A	4.8A	4A	3.2A	2.65A	2.28A	2A	1.77A	
	RATED POWER	75W	96W	96W	96W	95.4W	95.76W	96W	95.58W	
	RIPPLE & NOISE (max.) Note.2	150mVp-p	150mVp-p	150mVp-p	200mVp-p	200mVp-p	200mVp-p	200mVp-p	200mVp-p	
	VOLTAGE ADJ. RANGE	Adjustable for A-Type only (via the built-in potentiometer)								
		13.5 ~ 17V	17 ~ 22V	22 ~ 27V	27 ~ 33V	33 ~ 40V	38 ~ 46V	43 ~ 53V	49 ~ 58V	
	CURRENT ADJ. RANGE	Adjustable for A-Type only (via the built-in potentiometer)								
		2.75 ~ 5A	2.64 ~ 4.8A	2.2 ~ 4A	1.76 ~ 3.2A	1.45 ~ 2.65A	1.25 ~ 2.28A	1.1 ~ 2A	0.97 ~ 1.77A	
	VOLTAGE TOLERANCE Note.3	±2.0%	±1.0%	±1.0%	±1.0%	±1.0%	±1.0%	±1.0%	±1.0%	
	LINE REGULATION	±0.5%	±0.5%	±0.5%	±0.5%	±0.5%	±0.5%	±0.5%	±0.5%	
LOAD REGULATION	±1.5%	±0.5%	±0.5%	±0.5%	±0.5%	±0.5%	±0.5%	±0.5%		
SETUP, RISE TIME Note.6	500ms, 80ms/230VAC, 347VAC, 480VAC									
HOLD UP TIME (Typ.)	30ms/347VAC, 480VAC									
INPUT	VOLTAGE RANGE Note.5	180 ~ 528VAC 254VDC ~ 747VDC (Please refer to "STATIC CHARACTERISTIC" section)								
	FREQUENCY RANGE	47 ~ 63Hz								
	POWER FACTOR (Typ.)	PF ≥ 0.98/230VAC, PF ≥ 0.98/277VAC, PF ≥ 0.97/347VAC, PF ≥ 0.93/480VAC @full load (Please refer to "POWER FACTOR (PF) CHARACTERISTIC" section)								
	TOTAL HARMONIC DISTORTION	THD < 20% (@ load ≥ 50%/230VAC, 277VAC, 347VAC (@ load ≥ 60% only for 15V model); @ load ≥ 75%/480VAC) (Please refer to "TOTAL HARMONIC DISTORTION (THD)" section)								
	EFFICIENCY (Typ.)	89%	90%	91%	91%	90.5%	90.5%	91%	91%	
	AC CURRENT (Typ.)	0.38A / 347VAC 0.28A / 480VAC								
	INRUSH CURRENT (Typ.)	COLD START 25A(twidth=900μs measured at 50% Ipeak) at 480VAC; Per NEMA 410								
	MAX. No. of PSUs on 16A CIRCUIT BREAKER	5 units (circuit breaker of type B) / 8 units (circuit breaker of type C) at 480VAC								
PROTECTION	LEAKAGE CURRENT	<0.75mA / 480VAC								
	OVER CURRENT	95 ~ 108% Constant current limiting, recovers automatically after fault condition is removed								
	SHORT CIRCUIT	Constant current limiting, recovers automatically after fault condition is removed								
	OVER VOLTAGE	18 ~ 21V	23 ~ 27V	28 ~ 34V	34 ~ 38V	41 ~ 46V	47 ~ 53V	54 ~ 60V	59 ~ 65V	
	OVER TEMPERATURE	Shut down o/p voltage with auto-recovery or re-power on to recovery								
ENVIRONMENT	WORKING TEMP.	Tcase=-40 ~ +90°C (Please refer to "OUTPUT LOAD vs TEMPERATURE" section)								
	MAX. CASE TEMP.	Tcase=+90°C								
	WORKING HUMIDITY	20 ~ 95% RH non-condensing								
	STORAGE TEMP., HUMIDITY	-40 ~ +80°C, 10 ~ 95% RH								
	TEMP. COEFFICIENT	±0.03%/°C (0 ~ 60°C)								
SAFETY & EMC	VIBRATION	10 ~ 500Hz, 5G 12min./1cycle, period for 72min. each along X, Y, Z axes								
	SAFETY STANDARDS	UL8750(type"HL"), CSA C22.2 No. 250.0-08(except for 42V,48V, 54V), IP65 or IP67 approved								
	WITHSTAND VOLTAGE	I/P-O/P:3.75KVAC I/P-FG:2KVAC O/P-FG:1.5KVAC								
	ISOLATION RESISTANCE	I/P-O/P, I/P-FG, O/P-FG:100M Ohms / 500VDC / 25°C / 70% RH								
	EMC EMISSION	Compliance to EN55015, EN61000-3-2 Class C (@ load ≥ 50% load, @ load ≥ 60% only for 15V model); EN61000-3-3, FCC Part 15 Subpart B								
OTHERS	EMC IMMUNITY	Compliance to EN61000-4-2,3,4,5,6,8,11, EN61547, light industry level (surge immunity Line-Earth 4KV, Line-Line 2KV)								
	MTBF	174.9K hrs min. MIL-HDBK-217F (25°C)								
	DIMENSION	236*68*38.8mm (L*W*H)								
NOTE	PACKING	1.18Kg; 12pcs/15.2Kg/0.74CUFT								
		<ol style="list-style-type: none"> <li>All parameters NOT specially mentioned are measured at 347VAC input, rated load and 25°C of ambient temperature.</li> <li>Ripple &amp; noise are measured at 20MHz of bandwidth by using a 12" twisted pair-wire terminated with a 0.1uf &amp; 47uf parallel capacitor.</li> <li>Tolerance : includes set up tolerance, line regulation and load regulation.</li> <li>Please refer to "DRIVING METHODS OF LED MODULE".</li> <li>De-rating may be needed under low input voltages. Please refer to "STATIC CHARACTERISTIC" sections for details.</li> <li>Length of set up time is measured at first cold start. Turning ON/OFF the driver may lead to increase of the set up time.</li> <li>The driver is considered as a component that will be operated in combination with final equipment. Since EMC performance will be affected by the complete installation, the final equipment manufacturers must re-qualify EMC Directive on the complete installation again.</li> <li>This series meets the typical life expectancy of &gt;50,000 hours of operation when Tcase, particularly (Tc) point (or TMP, per DLC), is about 80°C or less.</li> </ol>								



**100W LED Driver power supply < HVG-100**

**Block Diagram**

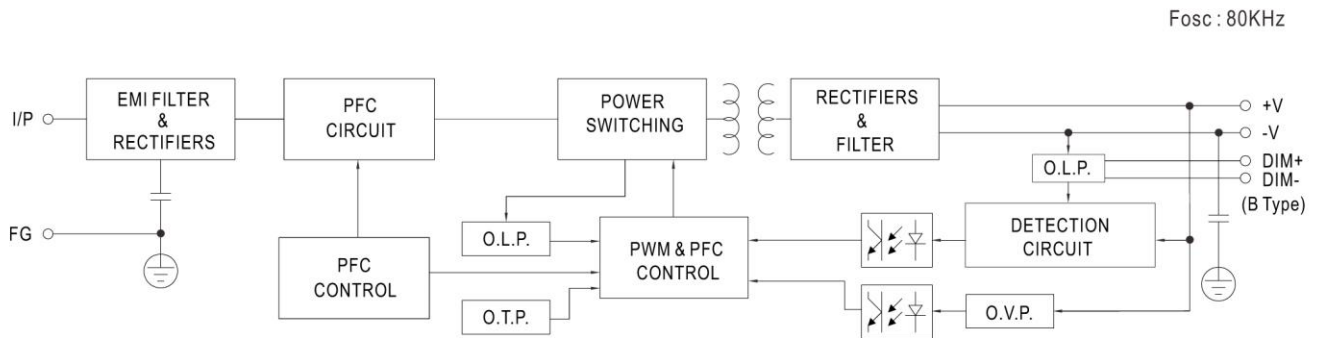

**DRIVING METHODS OF LED MODULE**

※ This series is able to work in either Constant Current mode (a direct drive way) or Constant Voltage mode (usually through additional DC/DC driver) to drive the LEDs.

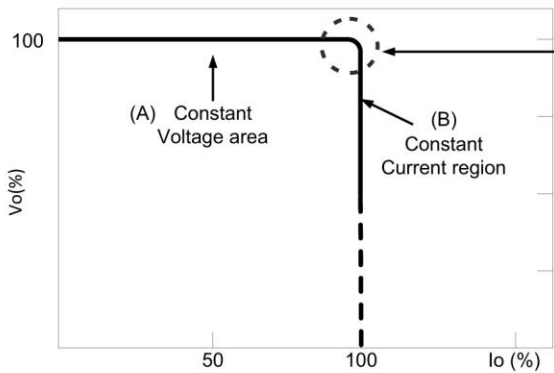

In the constant current region, the highest voltage at the output of the driver depends on the configuration of the end systems.

Typical output current normalized by rated current (%)

**100W LED Driver power supply < HVG-100**

**■ DIMMING OPERATION**

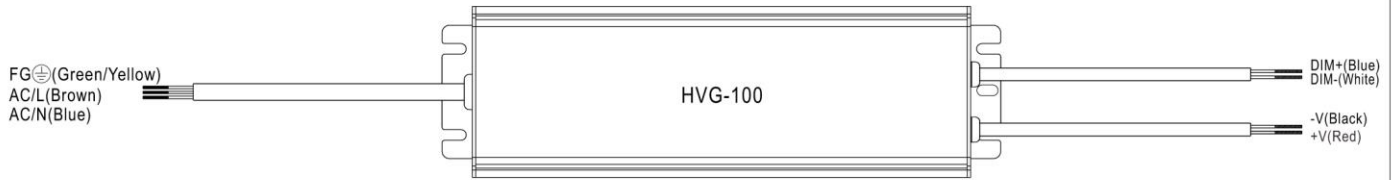

※ 3 in 1 dimming function (for B-Type)

- Output constant current level can be adjusted by applying one of the three methodologies between DIM+ and DIM-:  
 0 ~ 10VDC, or 10V PWM signal or resistance.
- Direct connecting to LEDs is suggested. It is not suitable to be used with additional drivers.
- Dimming source current from power supply: 100 $\mu$ A (typ.)

◎ Applying additive 0 ~ 10VDC

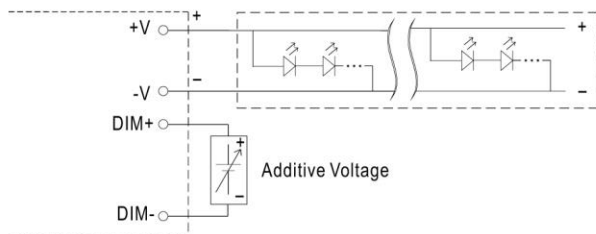

"DO NOT connect "DIM- to -V"

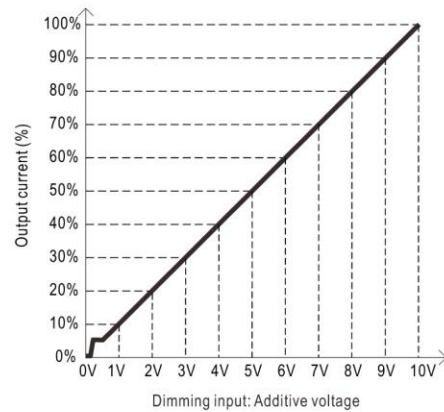

◎ Applying additive 10V PWM signal (frequency range 100Hz ~ 3KHz):

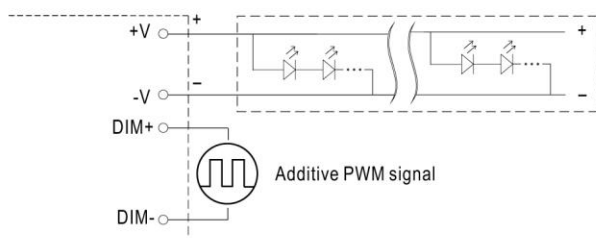

"DO NOT connect "DIM- to -V"

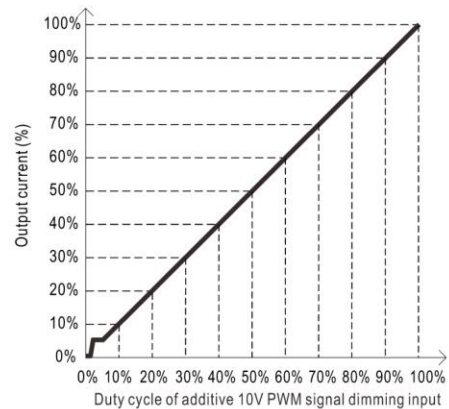

◎ Applying additive resistance:

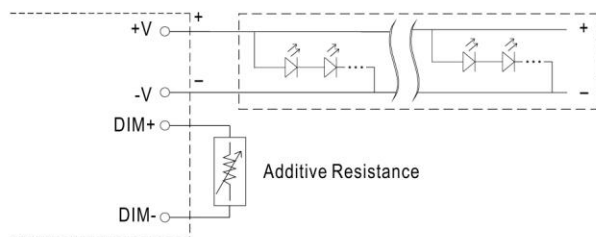

"DO NOT connect "DIM- to -V"

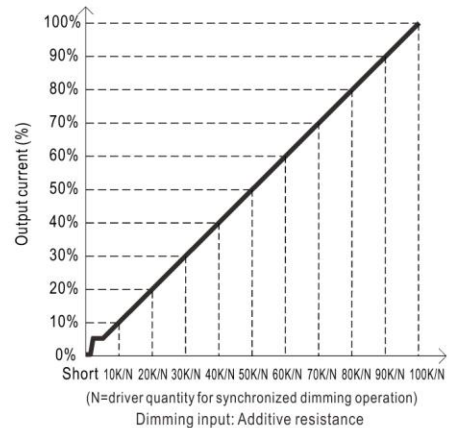

Note : 1. Min. dimming level is about 8% and the output current is not defined when 0% < Iout < 8%.  
 2. The output current could drop down to 0% when dimming input is about 0k $\Omega$  or 0Vdc, or 10V PWM signal with 0% duty cycle.



**100W LED Driver power supply < HVG-100**

**OUTPUT LOAD vs TEMPERATURE**

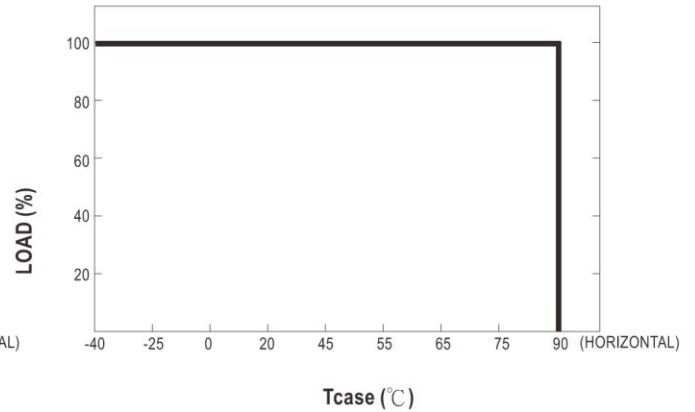
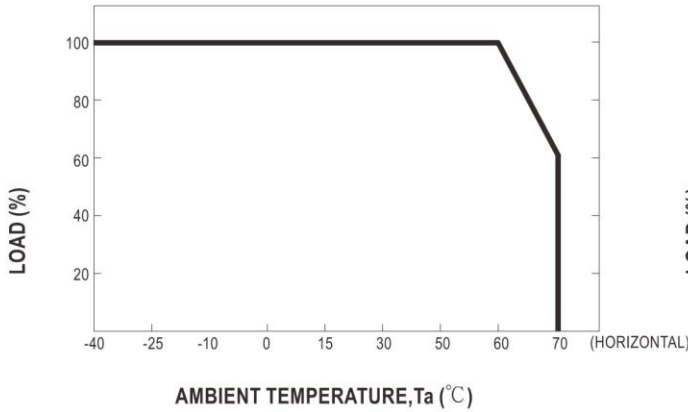

**STATIC CHARACTERISTIC**

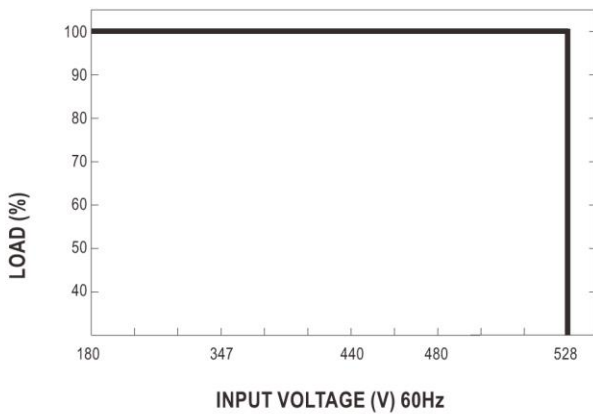

**POWER FACTOR (PF) CHARACTERISTIC**

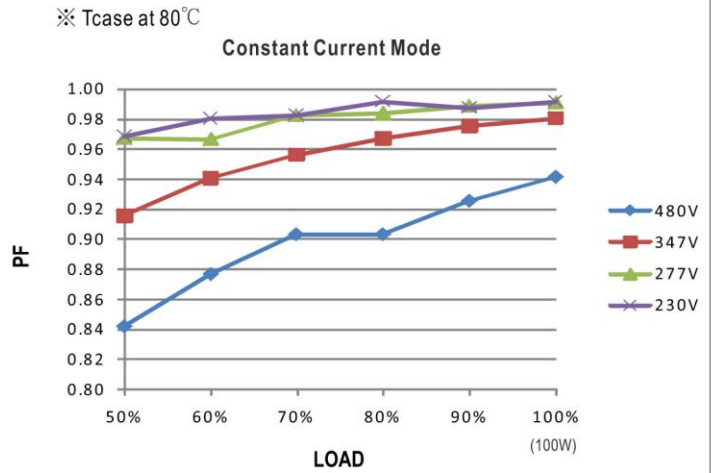

**TOTAL HARMONIC DISTORTION (THD)**

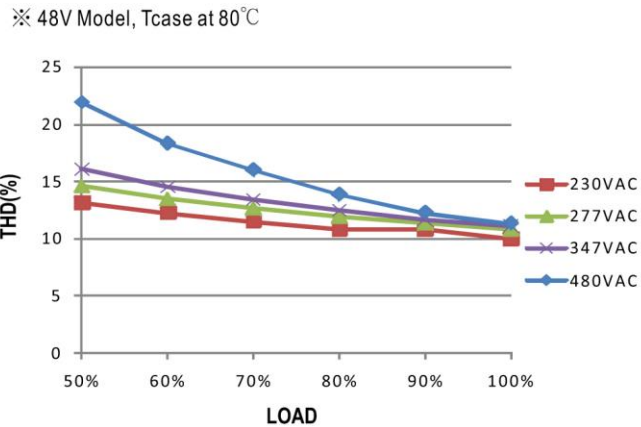

**EFFICIENCY vs LOAD**

HVG-100 series possess superior working efficiency that up to 91% can be reached in field applications.

※ 48V Model, Tcase at 80°C

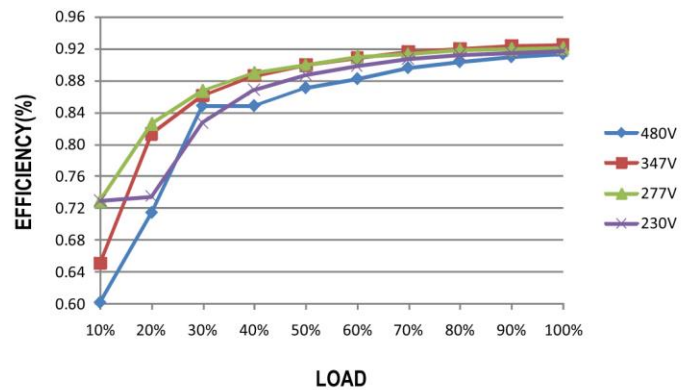



E-Star Power Development Co., Ltd. (E-STAR)  
1F, No.40, Juren Ln., Sec. 2, Sanmin Rd., Banciao Dist., New Taipei City  
22069, Taiwan (R.O.C.)  
Phone : 886-2-2957 5580 Fax : 886-2-2957 7473

**100W LED Driver power supply < HVG-100**

■ LIFE TIME

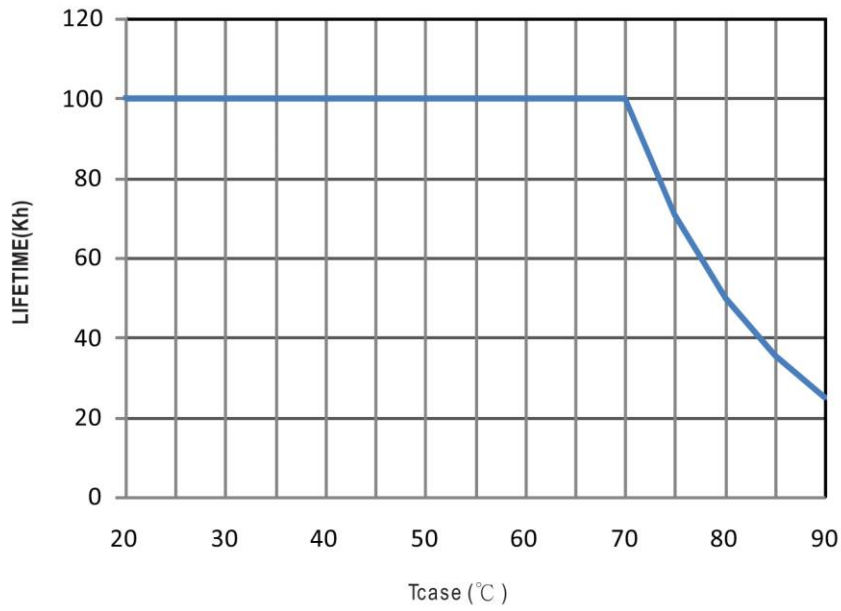



E-Star Power Development Co., Ltd. (E-STAR)

1F, No.40, Juren Ln., Sec. 2, Sanmin Rd., Banciao Dist., New Taipei City 22069, Taiwan (R.O.C.)

Phone : 886-2-2957 5580 Fax : 886-2-2957 7473

**100W LED Driver power supply < HVG-100**

**MECHANICAL SPECIFICATION**

Case No. 994

Unit:mm

※ **A-Type**

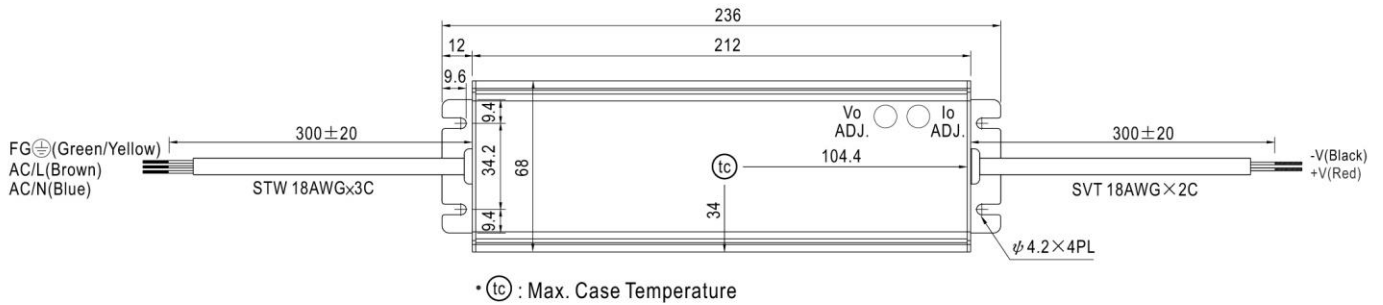

※ **B-Type**

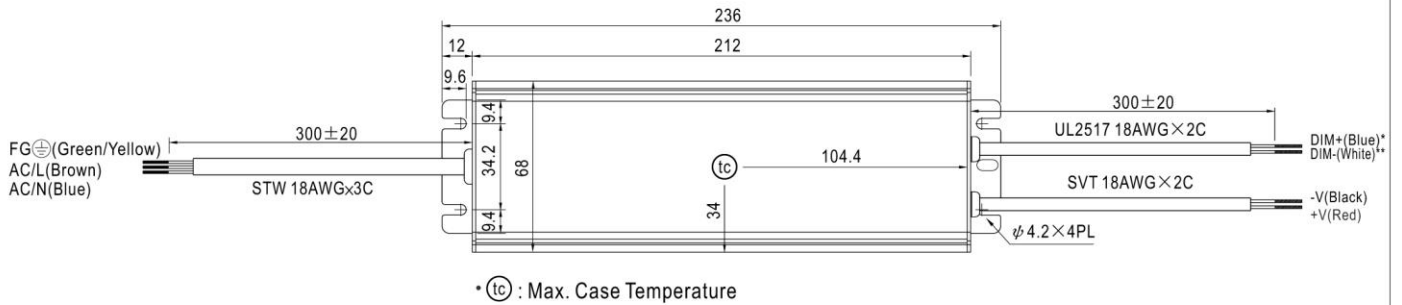

※ **D-Type**

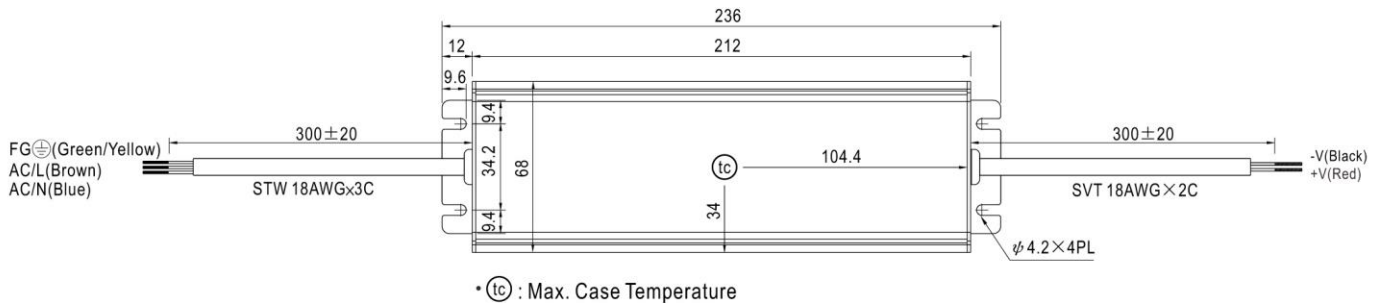

**100W LED Driver power supply < HVG-100**

**WATERPROOF CONNECTION**

※ Waterproof connector

Waterproof connector can be assembled on the output cable of HVG-100 to operate in dry/wet/damp or outdoor environment.

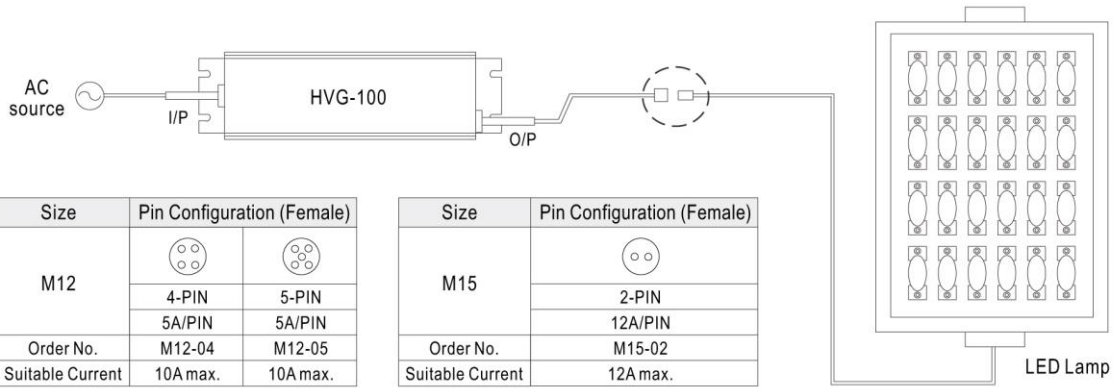

※ Cable Joiner

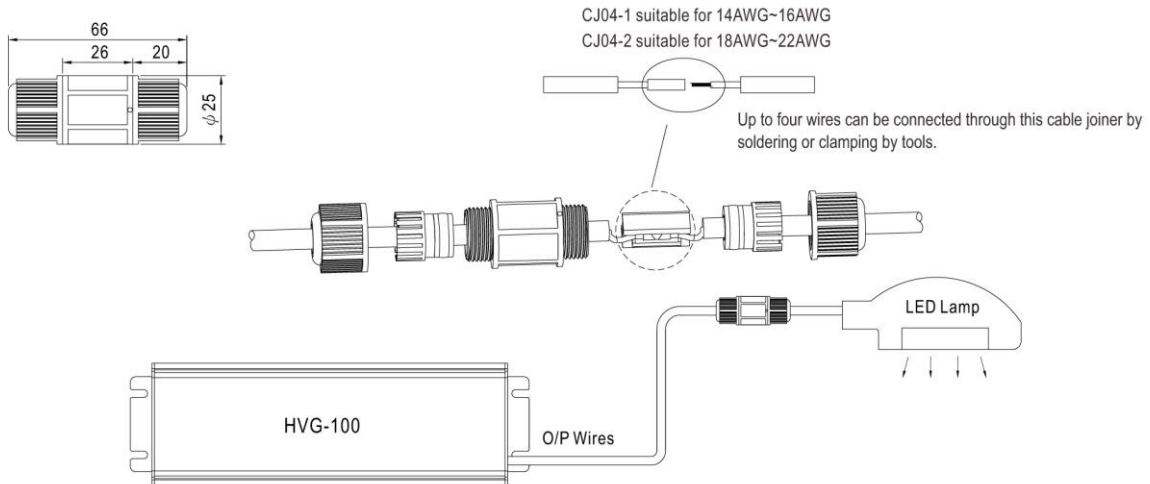

◎ CJ04 cable joiner can be purchased independently for user's own assembly.  
 MEAN WELL order No. : CJ04-1, CJ04-2.

※ Junction Box Option

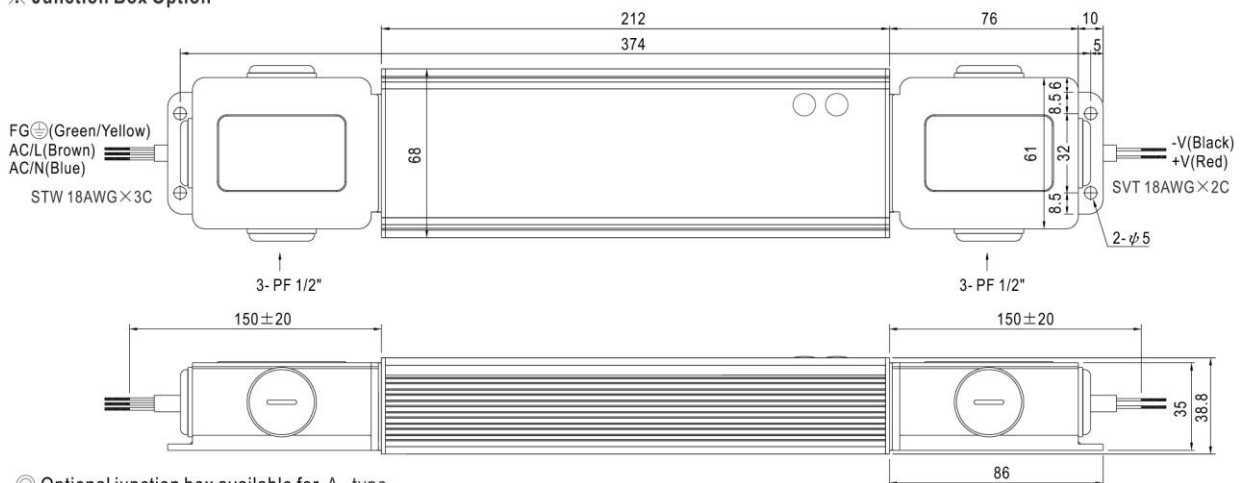

◎ Optional junction box available for A-type.