



E-Star Power Development Co., Ltd. (E-STAR)  
 1F., No.40, Juren Ln., Sec. 2, Sanmin Rd., Banciao Dist., New Taipei City  
 22069, Taiwan (R.O.C.)  
 Phone : 886-2-2957 5580 Fax : 886-2-2957 7473

**640mA Din Rail power supply < KNX-20E-640**



**■ Features**

- EIB / KNX power supply with integrated choke
- Compact size with 3SU(52.5mm) width
- Safety extra low voltage(SELV)
- 180~264VAC input
- No load power consumption <0.5W
- Protections: Short circuit / Overload(short-circuit-proof) / Over voltage
- Cooling by free air convection
- Isolation class I
- LED indicator for normal operation, bus reset and bus overload
- Installed on DIN rail TS-35/7.5 or 15
- Over voltage category III
- 100% full load burn-in test
- 3 years warranty

**■ Applications**

- Intelligent home control
- Modern building automation
- Lighting control
- HVAC system
- Security system
- Blinds and shutters
- Monitoring systems
- Energy management
- Alarm monitoring

**■ Description**

The KNX Power Supply KNX-20E-640 is a 640mA power supply with high efficiency and a small footprint of only 3SU (52.5 mm). The device has a KNX bus choke output and an additional output for ancillary power. The -30~+70°C wide temperature operating range can meet all kinds of applications. LED indicators are used in case of normal operation, overload conditions and RESET operation. It is perfectly suitable to power up any products labeled with the KNX trademark. With over 30 years of industrial power supply experience, KNX-20E-640 is engineered to be a reliable and safe solution for KNX bus environment.

**■ Model Encoding**

**KNX - 20E - 640**

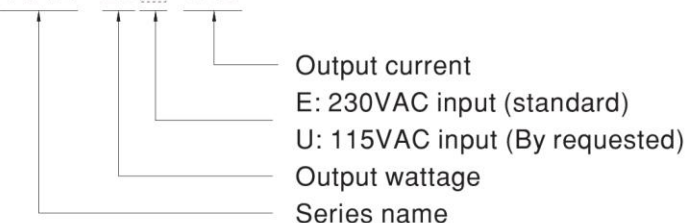



**640mA Din Rail power supply < KNX-20E-640**

**SPECIFICATION**

MODEL		KNX-20E-640
OUTPUT	BUS OUTPUT VOLTAGE WITH CHOKE	Bus,30V (KNX black/red terminal block)
	DC OUTPUT VOLTAGE WITHOUT CHOKE	30V(Additional output for ancillary power)
	RATED CURRENT	640mA
	RATED POWER	19.2W
	RIPPLE & NOISE (max.) Note.2	100mVp-p
	SHORT CIRCUIT CURRENT	1.4A
	SETUP, RISE TIME	1000ms, 50ms/230VAC at full load
	AC MAINS FAILURE BACK-UP TIME(Typ.)	200ms/230VAC at full load
INPUT	VOLTAGE RANGE	180 ~ 264VAC 230 ~ 370VDC
	FREQUENCY RANGE	47 ~ 63Hz
	EFFICIENCY (Typ.) Note.3	86%
	AC CURRENT (Typ.)	0.22A/230VAC
	INRUSH CURRENT (Typ.)	COLD START 40A/230VAC
	LEAKAGE CURRENT	<1mA / 240VAC
PROTECTION	OVERLOAD	205 ~ 235% rated output power Protection type : Constant current limiting, recovers automatically after fault condition is removed
	OVER VOLTAGE	33 ~ 35V Protection type : Shut down o/p voltage, re-power on to recover
FUNCTION	RESET	Physical button for reset the bus (Press the RESET button for at least 20 seconds to reset the KNX Bus)
	LED DISPLAY	Green LED (ON) :Normal operation Red LED1 (Reset):Reset the bus; Red LED2 ( $I > I_{max}$ ):Overload/Short
	CHOKE	One integrated choke
ENVIRONMENT	WORKING TEMP.	-30 ~ +70°C (Refer to "Derating Curve")
	WORKING HUMIDITY	20 ~ 95% RH non-condensing
	STORAGE TEMP., HUMIDITY	-40 ~ +85°C, 10 ~ 95% RH non-condensing
	VIBRATION TYPE OF PROTECTION	10 ~ 500Hz, 2G 10min./1cycle, 60min. each along X, Y, Z axes
	TYPE OF PROTECTION	IP20 design
	OVER VOLTAGE CATEGORY	III ; According to EN61558, EN50178, EN60664-1, EN62477-1 ; altitude up to 2000 meters
SAFETY & EMC (Note 4)	SAFETY STANDARDS	EN61558-1, EN61558-2-16 ; EN50491-3, EAC TP TC 004 approved
	WITHSTAND VOLTAGE	I/P-O/P:4KVAC I/P-FG:2KVAC O/P-FG:0.6KVAC
	ISOLATION RESISTANCE	I/P-O/P, I/P-FG:100M Ohms / 500VDC / 25°C / 70% RH
	EMC EMISSION	Compliance to EN50491-5-2,-5-3 ; EN61000-3-2,-3-3, EAC TP TC 020
	EMC IMMUNITY	Compliance to EN50491-5-2,-5-3 ; EN61000-4-2,3,4,5,6,8,11, heavy industry level, criteria A, EAC TP TC 020
OTHERS	MTBF	109K hrs min. MIL-HDBK-217F (25°C)
	DIMENSION	52.5*90*54.5mm (W*H*D)
	MOUNTING	35mm mounting rail according to DIN EN60715
	PACKING	0.215Kg ; 60pcs/13.9Kg/0.97CUFT
NOTE	<ol style="list-style-type: none"> <li>All parameters NOT specially mentioned are measured at 230VAC input, rated load and 25°C of ambient temperature.</li> <li>Ripple &amp; noise are measured at 20MHz of bandwidth by using a 12" twisted pair-wire terminated with a 0.1uF &amp; 47uF parallel capacitor. Measure before Choke.</li> <li>Efficiency before choke.</li> <li>The power supply is considered a component which will be installed into a final equipment. The final equipment must be re-confirmed that it still meets EMC directives. For guidance on how to perform these EMC tests, please refer to "EMI testing of component power supplies."</li> <li>The ambient temperature derating of 3.5°C/1000m with fanless models and of 5°C/1000m with fan models for operating altitude higher than 2000m(6500ft).</li> </ol>	

**640mA Din Rail power supply < KNX-20E-640**

**Block Diagram**

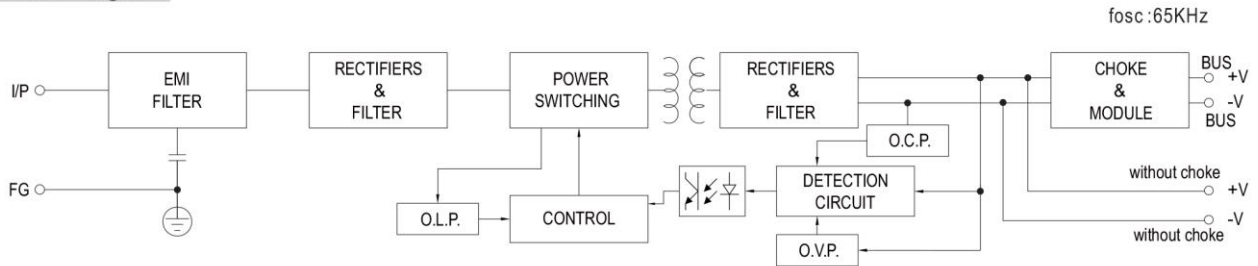

**Derating Curve**

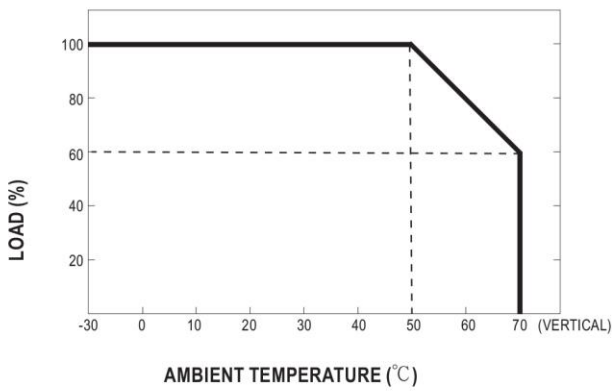

**Static Characteristics**

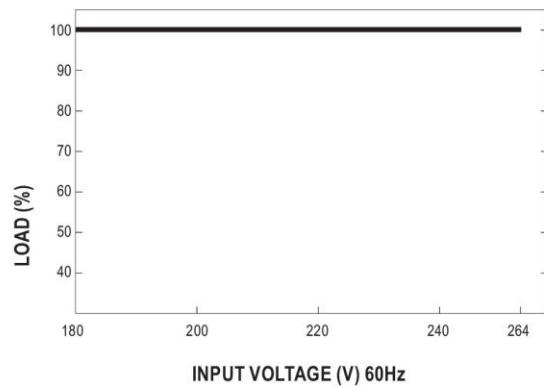

**Mechanical Specification**

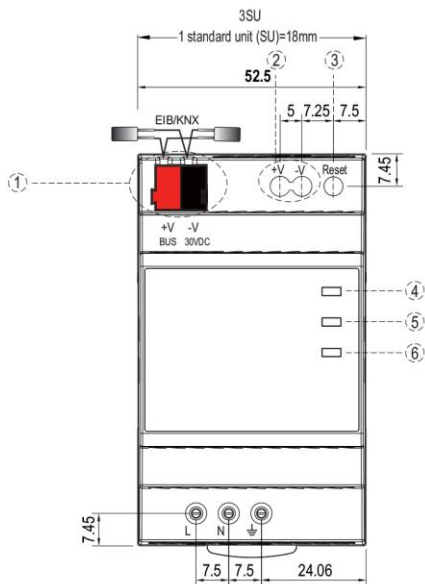

Case No. KNX-20 Unit:mm

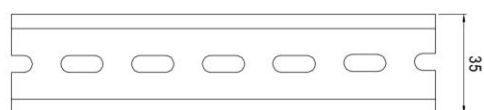
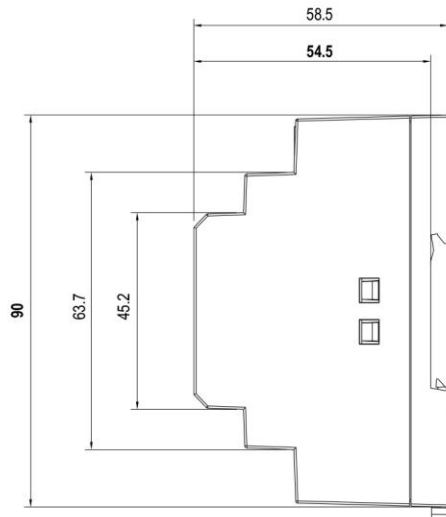

ADMISSIBLE DIN-RAIL: TS35/7.5 OR TS35/15

1	KNX bus terminals (Red :+, Black:-)
2	Ancillary power terminals
3	Reset button
4	Power ON (Green)
5	Reset (Red)
6	I > I max (Red)

**640mA Din Rail power supply < KNX-20E-640**

**■ Configuration and Commissioning**

The application program(data base) for ETS can be downloaded via  
<http://www.meanwell.com/productCatalog.aspx>

**■ Typical application**

◎ **Application 1:Powering KNX Bus Only**

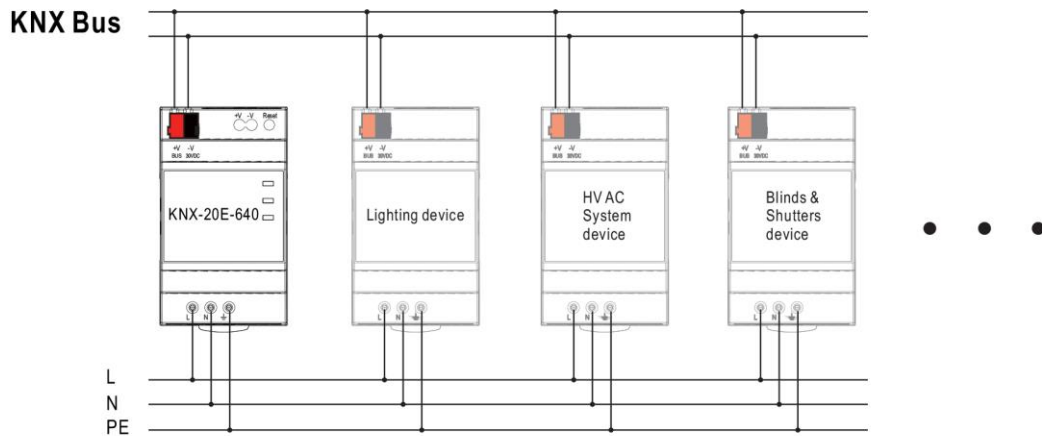

Bus wiring consideration:

1. the maximum number of bus devices connected is 64.
2. the maximum length of a line segment is 350 m, measured along the line between the power supply and the furthest device bus.
3. the maximum distance between two bus devices cannot exceed 700 m.
4. the maximum length of a bus line is 1000 m, keeping into account all segments.
5. It is possible to connect two KNX-20E-640 in parallel in same KNX line without minimum cable length.

◎ **Application 2:Powering KNX Bus and KNX device**

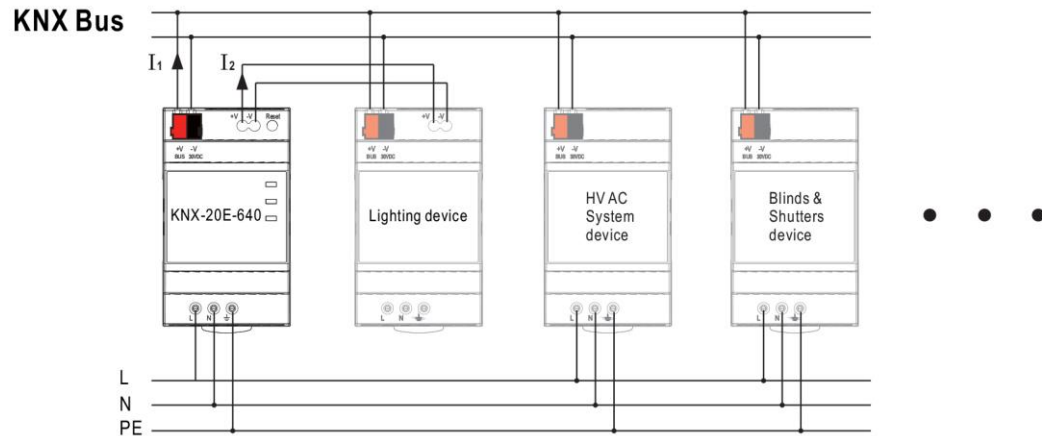

Note:

1. Use only ancillary output of KNX-20E-640 to power the KNX device
2. The total current  $I_1 + I_2$  should be equal or less than 640mA.  $I_1 + I_2 \leq 640\text{mA}$
3. The above Bus wiring consideration is still applicable

**■ Recommended Screwdriver, Wire and Torque Setting**

1. Screwdriver(Width\*Thick): Slotted screwdriver 2.5\*0.4~3.5\*0.6
2. Wire: 0.5~4.0mm<sup>2</sup> solid core or 0.5~2.5mm<sup>2</sup> finely stranded
3. Torque: 0.8Nm